

Elettrodomestici

Catalogo
solo
Cucine

Live, Cook, Love.

 **ILVE**

 **inox**
ELETTRODOMESTICI DA INCASSO

086 — 087

Blocchi cottura

- Majestic
- Panoramagic
- Nostalgie
- Professional Plus
- Pro Line











050 — 051

Il colore

I sistemi cottura ILVE affascinano tutti i sensi. Anche il colore diventa parte integrante della loro personalità estetica e di quella dell'intero ambiente cucina: un linguaggio che esprime i tuoi gusti e il tuo stile. Per questo ILVE ha messo a punto una gamma selezionata di colori, in sintonia con le principali tendenze dell'arredo: classiche o contemporanee, minimal o chic, per interpretare in modi diversi la bellezza della tecnologia.

Colori RAL Classic.

Vuoi una realizzazione con un sapore visivo unico, in perfetta sintonia con l'interior design della tua casa? Oltre a scegliere fra i colori disponibili a catalogo, puoi richiedere una fra le tantissime tonalità della gamma RAL Classic. Una versatilità cromatica resa possibile dalla flessibilità del processo produttivo ILVE e dalla sua capacità di soddisfare ogni tuo desiderio.

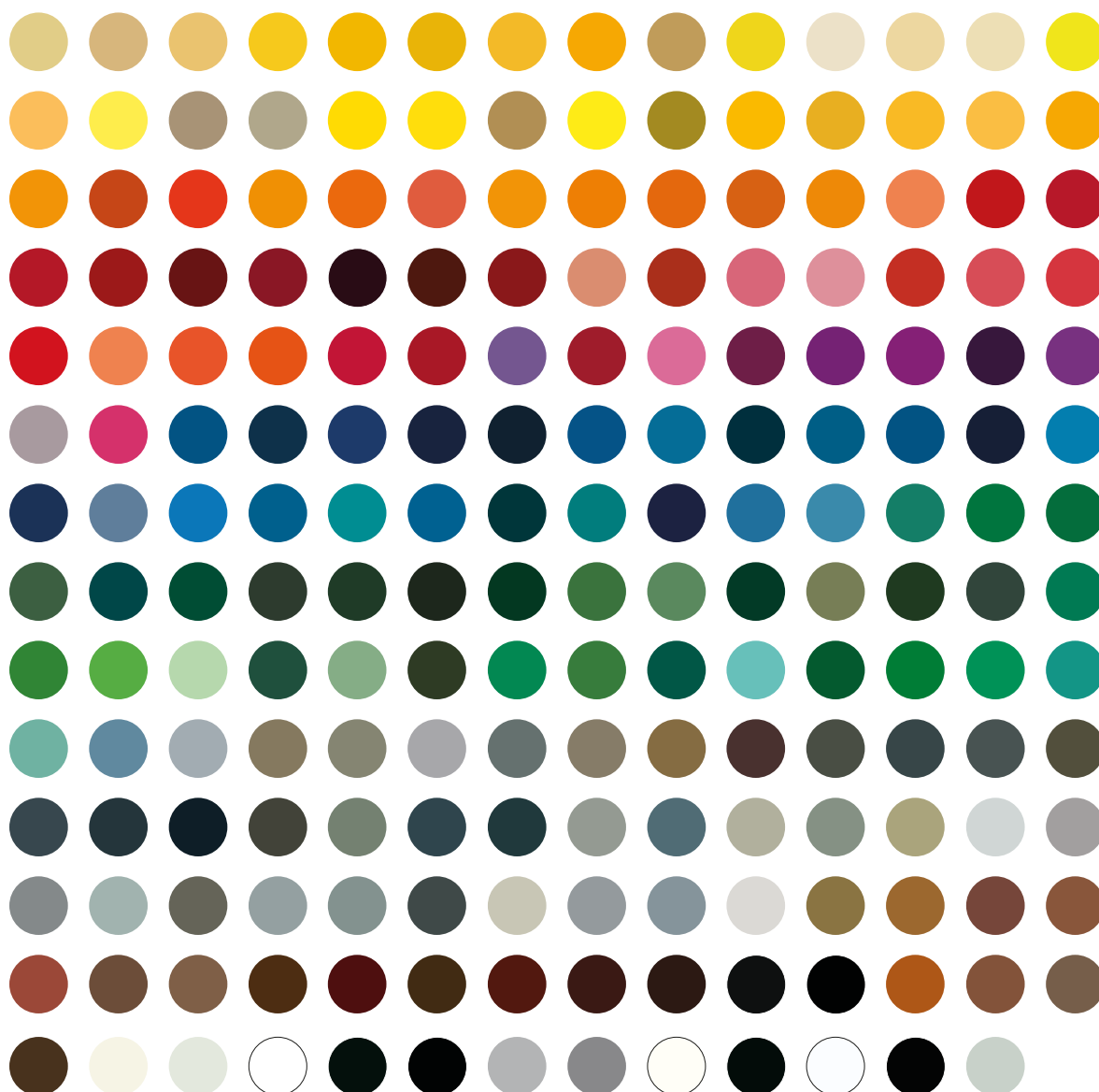



Color of the Year.

Ogni anno designer e creativi selezionano il Color of the Year: ILVE accoglie questo suggerimento grazie alla sua tecnologia produttiva, lo trasforma in una proposta che abbina al gusto di cucinare con grande professionalità, il piacere di essere in linea con le tendenze del momento, con una qualità destinata a non passare mai di moda.



2017
Light Green

RAL Classic 6027



2020
Classic Blue

PANTONE® 19-4052



2021
Ultimate Gray & Illuminating

PANTONE® 17-5104 - PANTONE® 13-0647



2018
Ultra Violet

PANTONE® 18-3838



2019
Living Coral

RAL Classic 3022



2022
Very Peri

PANTONE® 17-3938



2023
Viva Magenta

PANTONE® 18-1750

Majestic

I blocchi cottura Majestic sono elettrodomestici che arredano con le loro forme arrotondate, forgiate in puro acciaio e curate nei minimi dettagli. Rappresentano degli autentici gioielli di professionalità, pensati per la cucina di casa. Sono disponibili in una gamma di colori selezionati o in tonalità RAL Classic su richiesta, abbinati a preziose finiture metalliche.

Proposti in un'ampia scelta dimensionale (da 70 cm a 150 cm), offrono molteplici possibilità di allestimento.

Il forno può essere elettrico o a gas nelle misure fino a 90 cm oppure doppio in quelle fino a 150 cm; il controllo è touch e la temperatura può arrivare a 320° C.

Per il piano cottura si possono scegliere cinque configurazioni: bruciatori a gas dual, coupe de feu o fry top sono alcune opzioni disponibili per la versione a gas, mentre la versione a induzione totale è disponibile fino al modello da 120 cm con 7 zone cottura e funzione bridge.

Gamma colori

Scocca



Bianco - WH



Bianco
antico - AW



Inox - SS



Grafite
mat - MG



Nero
lucido - BK



Blu - MB



Rosso
Borgogna - BU



Verde
smeraldo - EG



RAL
Ral Classic
opzionale - RA
+ € 800,00

Finiture

Manopole, maniglie, piedini, cornici



Ottone - G



Cromo - C



Brunito - B



Rame - P



Bruciatori a gas Dual con potenza fino a 5 kW di serie



Piani cottura ad alta specializzazione



Controllo elettronico della temperatura puntuale



Porta fredda con triplo vetro estraibile



Display 4,3" full touch



Spartifiamma in ottone Total Black con trattamento nanotecnologico antiaderente



Piano cottura con griglie in ghisa



Controllo unico dei due forni



Porta e cassetto con sistema soft-closing



Scarico vapore



Sonda di cottura



↑ M15FDNE3/WHB
Blocco cottura Majestic da 150 cm
con 7 zone cottura e piastra Fry top
Bianco con finiture brunito

Abaco colori e finiture



Bianco
antico - AW



Bianco - WH



Inox - SS



Grafite
mat - MG



Cromo - C



Ottone - G



Rame - P





Brunito - B



 Nero
lucido - BK

 Blu - MB

 Verde
smeraldo - EG

 Rosso
Borgogna - BU



Cromo - C



Ottone - G



Rame - P



Brunito - B

Forni disponibili per blocchi cottura Majestic

Caratteristiche generali

	<u>OV80 E3 TFT S</u>	<u>OV76 E3 TFT S</u>	<u>OV60 E3 TFT S</u>
	Forno elettronico da 80 cm	Forno elettronico da 30"	Forno elettronico da 60 cm
Classe energetica	A+	A	A+
Numero funzioni	15	15	15
Temperatura di esercizio	30-320°C	30-320°C	30-320°C
Programmatore	touch control TFT	touch control TFT	touch control TFT
Controllo elettronico della temperatura	Si	Si	Si
Sonda di cottura	Si	Si	Si
Illuminazione	Doppia luce interna	Doppia luce interna	Doppia luce interna
Chiusura porta soft-closing	Si	Si	Si
Vetri porta	Porta fredda a triplo vetro (EN60335-2-6-11.101)	Porta fredda a triplo vetro (EN60335-2-6-11.101)	Porta fredda a triplo vetro (EN60335-2-6-11.101)
Ventilazione	tangenziale di raffreddamento	tangenziale di raffreddamento	tangenziale di raffreddamento
Sicurezza bambini	Si	Si	Si
<u>Caratteristiche cavità</u>			
Muffola	con smalto easy clean	con smalto easy clean	con smalto easy clean
Dimensioni interne	64,5×36,5×41 cm	64×43,3×41 cm	43,7×36×41 cm
Capacità	97 L	114 L	65 L
Scarico vapori	a comando con opzione cottura a secco o umida	a comando con opzione cottura a secco o umida	a comando con opzione cottura a secco o umida
Resistenza grill abbattibile	Si	Si	Si
Girarrosto	diagonale	-	-
Termostato	con sonda elettronica	con sonda elettronica	con sonda elettronica
<u>Consumi</u>			
Assorbimento massimo	2,75 kW	3,1 kW	2,45 kW
Resistenza elettrica superiore	1200 W	1200 W	1000 W
Resistenza elettrica inferiore	1350 W	1560 W	1100 W
Grill elettrico	2150 W	3000 W	2100 W
Resistenza circolare	2100 W	2×1050 W	2100 W
Brucciore inferiore a gas	-	-	-

Funzioni

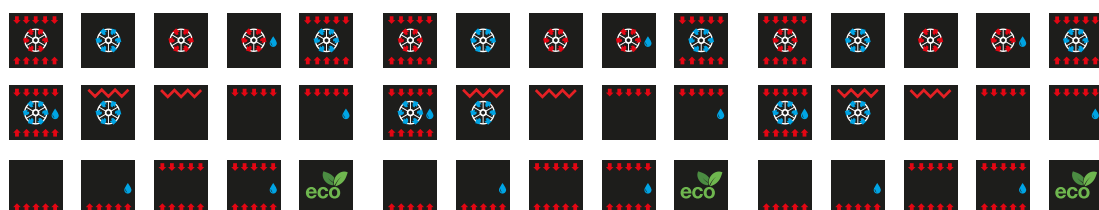

OV30 E3 TFT

Mini forno elettronico statico da 30 cm

A+

5

30-250°C

touch control TFT

Si

-

Luce interna

Si

Porta fredda a triplo vetro
(EN60335-2-6-11.101)

tangenziale di raffreddamento

Si

con smalto easy clean

27,5x35,5x44 cm

43 L

Si

-

Si

con sonda elettronica

2,4 kW

800 W

800 W

1500 W

-

-



M07N



Gamma colori

Scocca



Bianco
antico - AW



Bianco - WH



Blu - MB



Inox - SS



Grafite mat - MG



Nero lucido - BK



Rosso
Borgogna - BU



Verde
smeraldo - EG



Ral Classic - RA
optional + € 800

Finiture

Manopole, maniglie, cornici



Ottone - G



Rame - P



Cromo - C



Brunito - B

Forni disponibili

Forno elettrico

Forno principale:
OV 60 E3 TFT S

Assorbimento massimo:
2,45 kW

Configurazioni

4 fuochi

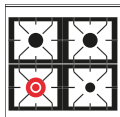

Forno elettrico

M07DNE3

Ottone/Cromo € 4.072,00

Rame/Brunito € 4.390,00

Potenze

 Bruciatore Dual
a doppia corona
5,0 kW / 0,3 kW

 Bruciatore
grande
3 kW / 0,6 kW

 Bruciatore
piccolo
1,8 kW / 0,4 kW

Complementi e accessori

Cappa AM70
€ 1.981,00

Pannello portamestoli AM4-70
€ 194,00

→ p. 308

Disegno tecnico e misure

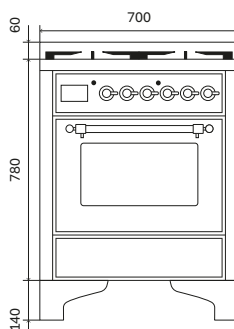
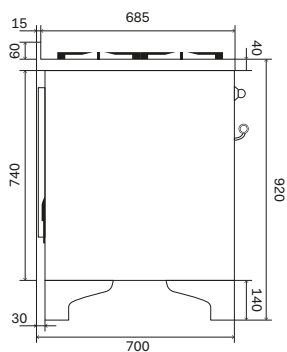

M30N



Gamma colori

Scocca



Bianco
antico - AW



Bianco - WH



Blu - MB



Inox - SS



Grafite mat - MG



Nero lucido - BK



Rosso
Borgogna - BU



Verde
smeraldo - EG



Ral Classic - RA
optional + € 800

Finiture

Manopole, maniglie, cornici



Ottone - G



Rame - P



Cromo - C



Brunito - B

Forni disponibili

Forno elettrico

Forno principale:
OV 76 E3 TFT S

Assorbimento massimo:
3,1 kW

Configurazioni

5 fuochi

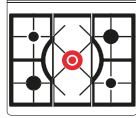

Forno elettrico

M30DNE3

Ottone/Cromo € 4.873,00

Rame/Brunito € 5.154,00

Potenze

 Bruciatore Dual
a doppia corona
5,0 kW / 0,3 kW

 Bruciatore
grande
3 kW / 0,6 kW

 Bruciatore
piccolo
1,8 kW / 0,4 kW

Complementi e accessori

→ p. 308

Cappa

AM76

€ 2.051,00

Pannello portamestoli

AM4-76

€ 209,00

Disegno tecnico e misure

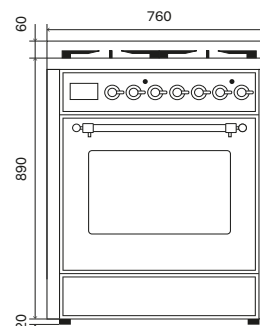
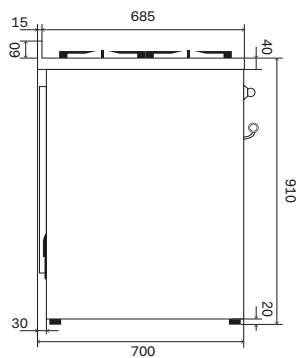

M09N



Gamma colori

Scocca



Bianco
antico - AW



Bianco - WH



Blu - MB



Inox - SS



Grafite mat - MG



Nero lucido - BK



Rosso
Borgogna - BU



Verde
smeraldo - EG



RAL
Ral Classic - RA
optional + € 800

Finiture

Manopole, maniglie, cornici



Ottone - G



Rame - P



Cromo - C



Brunito - B

Forni disponibili

Forno elettrico

Forno principale:
OV 80 E3 TFT S

Assorbimento massimo:
2,75 kW

Configurazioni

6 fuochi con fry top*

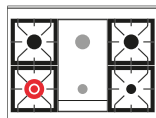

6 fuochi

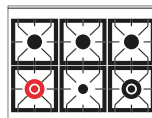

Pescera

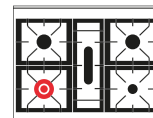

Forno elettrico

M09FDNE3

Ottone/Cromo € 5.665,00

Rame/Brunito € 5.891,00

M096DNE3

Ottone/Cromo € 5.317,00

Rame/Brunito € 5.558,00

M09PDNE3

Ottone/Cromo € 4.967,00

Rame/Brunito € 5.248,00

2 zone induzione

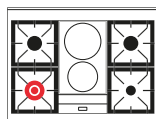

Induzione

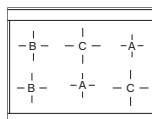

Forno elettrico

M09IDNE3

Ottone/Cromo € 5.700,00

Rame/Brunito € 5.936,00

MI096NE3

Ottone/Cromo € 6.349,00

Rame/Brunito € 6.589,00

* sostituire il Fry Top con le griglie KGRFT002 (p. 316) per un uso standard dei due bruciatori

Potenze

—B— Zona induzione Bridge
Ø 180+180 mm
3 kW / 1,85 kW
+3 kW / 1,85 kW

—A— Zona induzione
Ø 145 mm
2,2 kW / 1,4 kW

—B— Zona induzione
Ø 180 mm
3 kW / 1,85 kW

—C— Zona induzione
Ø 210 mm
3,7 kW / 2,3 kW

○ Induzione a due zone
2x1,85 kW
max. 3,7 kW

⊗ Bruciatore Dual a doppia corona
5,0 kW / 0,3 kW

⊗ Bruciatore a doppia corona
4,3 kW / 1,8 kW

● Piastra Fry Top due bruciatori
3 kW / 0,6 kW
1,8 kW / 0,4 kW

▭ Pescera
3,1 kW / 1,1 kW

⊗ Bruciatore grande
3 kW / 0,6 kW

⊗ Bruciatore piccolo
1,8 kW / 0,4 kW

Complementi e accessori

Cappa

AM90

€ 2.078,00

Pannello portamestoli

AM4-90

€ 254,00

→ p. 308

Disegno tecnico e misure

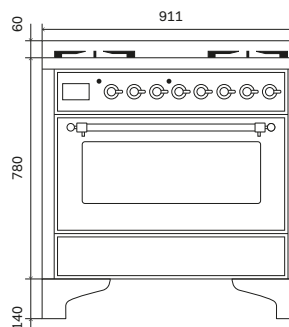
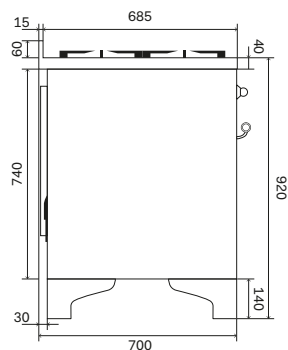

MD10N



Gamma colori

Scocca



Bianco
antico - AW



Bianco - WH



Blu - MB



Inox - SS



Grafite mat - MG



Nero lucido - BK



Rosso
Borgogna - BU



Verde
smeraldo - EG



RAL
Ral Classic - RA
optional + € 800

Finiture

Manopole, maniglie, cornici



Ottone - G



Rame - P



Cromo - C



Brunito - B

Forni disponibili

Forno elettrico

Forno principale:
OV 60 E3 TFT S

Forno secondario:
OV 30 E3 TFT

Assorbimento massimo:
2,45 kW

Assorbimento massimo:
2,4 kW

Configurazioni

6 fuochi con fry top*

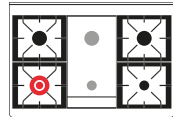

6 fuochi

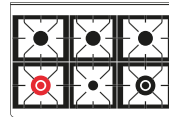

Coupe de feu

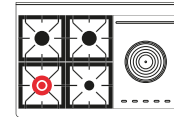

Forno elettrico

MD10FDNE3

Ottone/Cromo € 6.595,00
Rame/Brunito € 6.749,00

MD106DNE3

Ottone/Cromo € 6.338,00
Rame/Brunito € 6.635,00

MD10SDNE3

Ottone/Cromo € 6.504,00
Rame/Brunito € 6.796,00

2 zone induzione

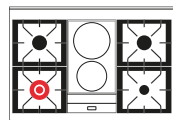

Induzione

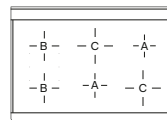

Forno elettrico

MD10IDNE3

Ottone/Cromo € 6.915,00
Rame/Brunito € 7.162,00

MDI106NE3

Ottone/Cromo € 7.417,00
Rame/Brunito € 7.710,00

* sostituire il Fry Top con le griglie KGRFT002 (p. 316) per un uso standard dei due bruciatori

Potenze

Zona induzione Bridge
 Ø 180+180 mm
 3 kW / 1,85 kW
 +3 kW / 1,85 kW

Zona induzione
 Ø 145 mm
 2,2 kW / 1,4 kW

Zona induzione
 Ø 180 mm
 3 kW / 1,85 kW

Zona induzione
 Ø 210 mm
 3,7 kW / 2,3 kW

Induzione a due zone
 2x1,85 kW
 max. 3,7 kW

Coup de Feu
 3 kW / 0,6 kW

Bruciatore Dual a doppia corona
 5,0 kW / 0,3 kW

Bruciatore a doppia corona
 4,3 kW / 1,8 kW

Piastra Fry Top due bruciatori
 3 kW / 0,6 kW
 1,8 kW / 0,4 kW

Bruciatore grande
 3 kW / 0,6 kW

Bruciatore piccolo
 1,8 kW / 0,4 kW

Complementi e accessori

Cappa

AM100

€ 2.134,00

Pannello portamestoli

AM4-100

€ 282,00

→ p. 308

Disegno tecnico e misure

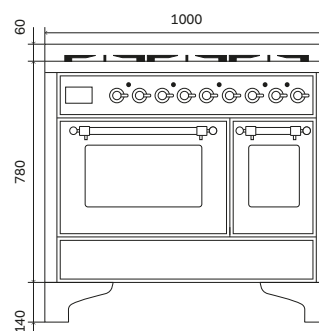
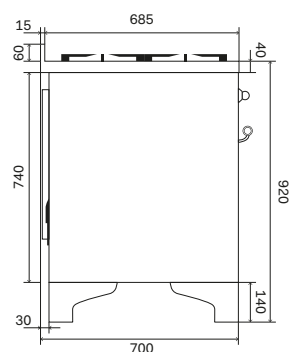

M12N



Gamma colori

Scocca



Bianco
antico - AW



Bianco - WH



Blu - MB



Inox - SS



Grafite mat - MG



Nero lucido - BK



Rosso
Borgogna - BU



Verde
smeraldo - EG



Ral Classic - RA
optional + € 800

Finiture

Manopole, maniglie, cornici



Ottone - G



Rame - P



Cromo - C



Brunito - B

Forni disponibili

Forno elettrico

Forno principale:
OV 80 E3 TFT S

Forno secondario:
OV 30 E3 TFT

Assorbimento massimo:
2,75 kW

Assorbimento massimo:
2,4 kW

Configurazioni

7 fuochi



8 fuochi con fry top*

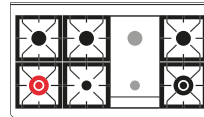

Coupe de feu



Forno elettrico

M127DNE3

Ottone/Cromo € 11.923,00
Rame/Brunito € 12.797,00

M12FDNE3

Ottone/Cromo € 11.923,00
Rame/Brunito € 12.797,00

M12SDNE3

Ottone/Cromo € 11.923,00
Rame/Brunito € 12.797,00

6 fuochi con fry top* e 2 zone induzione

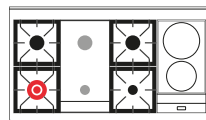

Induzione

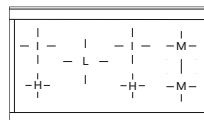

Forno elettrico

M12FIDNE3

Ottone/Cromo € 11.923,00
Rame/Brunito € 12.797,00

MI127NE3

Ottone/Cromo € 11.923,00
Rame/Brunito € 12.797,00

* sostituire il Fry Top con le griglie KGRFT002 (p. 316) per un uso standard dei due bruciatori

Potenze

Zona induzione
Bridge
210x380 mm
1,5+1,5 kW

Zona induzione
Ø 145 mm
1,85 kW / 1,4
kW

Zona induzione
Ø 200 mm
3,0 kW / 2,3 kW

Zona induzione
Ø 250 mm
3,0 kW / 2,3 kW

Zona induzione
210x190 mm
3,0 kW / 2,1 kW

Induzione
a due zone
2x1,85 kW
max. 3,7 kW

Coup de Feu
3 kW / 0,6 kW

Bruciatore Dual
a doppia corona
5,0 kW / 0,3 kW

Bruciatore
a doppia corona
4,3 kW / 1,8 kW

Piastra Fry Top
due bruciatori
3 kW / 0,6 kW
1,8 kW / 0,4 kW

Pescera
3,1 kW / 1,1 kW

Bruciatore
grande
3 kW / 0,6 kW

Bruciatore
piccolo
1,8 kW / 0,4 kW

Complementi
e accessori

Cappa

AM120

€ 2.572,00

Pannello portamestoli

AM4-120

€ 346,00

→ p. 308

Disegno tecnico
e misure

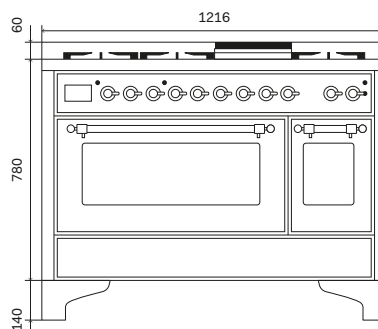
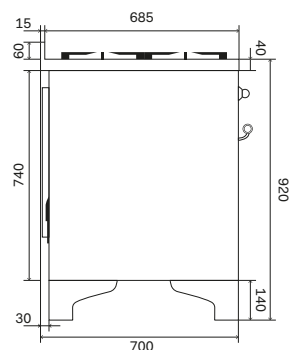

M15N



Gamma colori

Scocca



Bianco
antico - AW



Bianco - WH



Blu - MB



Inox - SS



Grafite mat - MG



Nero lucido - BK



Rosso
Borgogna - BU



Verde
smeraldo - EG



Ral Classic - RA
optional + € 800

Finiture

Manopole, maniglie, cornici



Ottone - G



Rame - P



Cromo - C



Brunito - B

Forni disponibili

Forno elettrico

Forno principale:
OV 80 E3 TFT S

Forno secondario:
OV 60 E3 TFT

Assorbimento massimo:
2,75 kW

Assorbimento massimo:
2,45 kW

Configurazioni

7 fuochi con fry top* e coup de feu

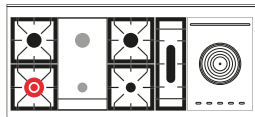

9 fuochi con fry top*

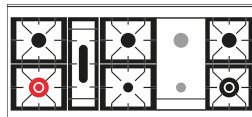

Coupe de feu

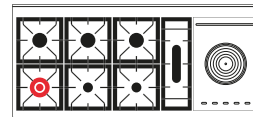

Forno elettrico

M15FSDNE3

Ottone/Cromo € 17.716,00
Rame/Brunito € 18.886,00

M15FDNE3

Ottone/Cromo € 17.716,00
Rame/Brunito € 18.886,00

M15SDNE3

Ottone/Cromo € 17.716,00
Rame/Brunito € 18.886,00

* sostituire il Fry Top con le griglie KGRFT002 (p. 316) per un uso standard dei due bruciatori

Potenze



Coup de Feu
3 kW / 0,6 kW



Bruciatore Dual
a doppia corona
5,0 kW / 0,3 kW



Bruciatore
a doppia corona
4,3 kW / 1,8 kW



Piastra Fry Top
due bruciatori
3 kW / 0,6 kW
1,8 kW / 0,4 kW



Pescera
3,1 kW / 1,1 kW



Bruciatore
grande
3 kW / 0,6 kW



Bruciatore
piccolo
1,8 kW / 0,4 kW

Complementi
e accessori

Cappa

AM150

€ 3.009,00

Pannello portamestoli

AM4-150

€ 417,00

→ p. 308

Disegno tecnico
e misure

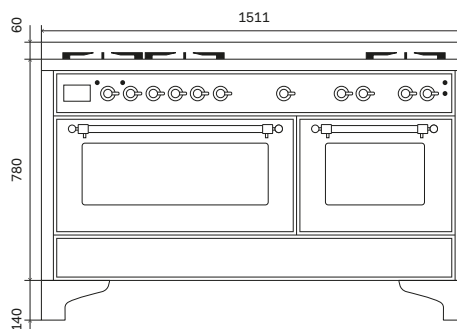
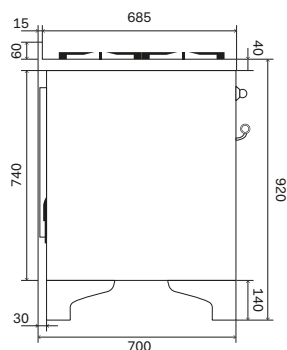

Panoramagic

Inimitabili nel design che unisce la tecnicità delle cucine professionali con la cultura italiana del progetto, i blocchi cottura Panoramagic sono proposti in tre modelli, tutti con schermo touch da 4,3 pollici: da 120 cm con doppio forno e controllo della temperatura puntuale, da 90 cm a 6 fuochi oppure con piano a induzione fino a 120 cm con 7 zone e funzione bridge. I piani a gas utilizzano bruciatori dual fino a 5 kW e un trattamento nanotecnologico altamente professionale per ottenere una superficie antiaderente con finitura total black.

Gamma colori

Scocca



Inox - SS



Nero opaco - MK

Finiture

Manopole, maniglie, piedini, cornici



Satinato



Spartifiamma in ottone Total Black con trattamento nanotecnologico antiaderente



Bruciatori a gas Dual con potenza fino a 5 kW di serie



Piani cottura ad alta specializzazione



Manopole retroilluminate a LED



Piano cottura con griglie in ghisa



Display 4,3" full touch



Controllo unico dei due forni



Porta con sistema soft-closing



Controllo elettronico della temperatura puntuale



Cassetto riscaldato con sistema soft-closing



Scarico vapori



Sonda di cottura



Porta fredda con triplo vetro estraibile



↑ PM128DS3/SS
Blocco cottura Panoramagic 120cm
Scocca e finiture acciaio

Forni disponibili per blocchi cottura Panoramic

Caratteristiche generali

	<u>OV80 E3 TFT S</u>	<u>OV30 E3 TFT</u>
	Forno elettronico da 80 cm	Mini forno elettronico statico da 30 cm
Classe energetica	A+	A+
Numero funzioni	15	5
Temperatura di esercizio	30-320°C	30-250°C
Programmatore	touch control TFT	touch control TFT
Controllo elettronico della temperatura	Si	Si
Sonda di cottura	Si	-
Illuminazione	Doppia luce interna	Luce interna
Chiusura porta soft-closing	Si	Si
Vetri porta	Porta fredda a triplo vetro (EN60335-2-6-11.101)	Porta fredda a triplo vetro (EN60335-2-6-11.101)
Ventilazione	tangenziale di raffreddamento	tangenziale di raffreddamento
Sicurezza bambini	Si	Si

Caratteristiche cavità

Muffola	con smalto easy clean	con smalto easy clean
Dimensioni interne	64,5x36,5x41 cm	27,5x35,5x44 cm
Capacità	97 L	43 L
Scarico vapori	a comando con opzione cottura a secco o umida	Si
Resistenza grill abbattibile	Si	-
Girarrosto	diagonale	Si
Termostato	con sonda elettronica	con sonda elettronica

Consumi

Assorbimento massimo	2,75 kW	2,4 kW
Resistenza elettrica superiore	1200 W	800 W
Resistenza elettrica inferiore	1350 W	800 W
Grill elettrico	2150 W	1500 W
Resistenza circolare	2100 W	-
Brucciato inferiore a gas	-	-

Funzioni





PM09-MK



Gamma colori

Scocca



Nero opaco - MK

Finiture



Satinato

Forni disponibili

Forno elettrico

Forno principale:
OV 80 E3 TFT S

Assorbimento massimo:
2,75 kW

Configurazioni

Induzione

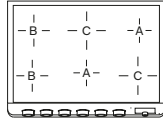

Forno elettrico

PMI09S3

Satinato

€ 7.243,00

Potenze

Zona induzione
Bridge
Ø 180+180 mm
3 kW / 1,85 kW
+3 kW / 1,85 kW

Zona induzione
Ø 145 mm
2,2 kW / 1,4 kW

Zona induzione
Ø 180 mm
3 kW / 1,85 kW

Zona induzione
Ø 210 mm
3,7 kW / 2,3 kW

Complementi e accessori

→ p. 308

Cappa

APM90

€ 2.403,00

Pannello portamestoli

AM4-90

€ 254,00

Disegno tecnico e misure

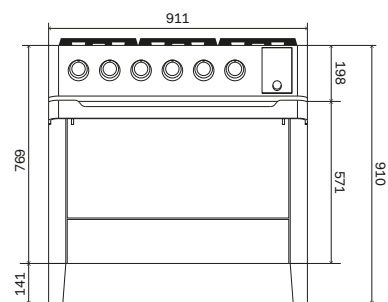
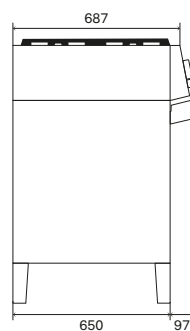

PM12-MK



Gamma colori

Scocca



Nero opaco - MK

Finiture



Satinato

Forni disponibili

Forno elettrico

Forno principale:
OV 80 E3 TFT S

Forno secondario:
OV 30 E3 TFT

Assorbimento massimo:
2,75 kW

Assorbimento massimo:
2,4 kW

Configurazioni

Induzione

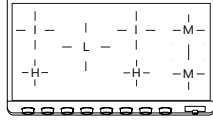

Forno elettrico

PMI127S3

Satinato

€ 14.834,00

Potenze

 Zona induzione
Bridge
210x380 mm
1,5+1,5 kW

 Zona induzione
Ø 145 mm
1,85 kW / 1,4
kW

 Zona induzione
Ø 200 mm
3,0 kW / 2,3 kW

 Zona induzione
Ø 250 mm
3,0 kW / 2,3 kW

 Zona induzione
210x190 mm
3,0 kW / 2,1 kW

Complementi
e accessori

→ p. 308

Cappa

APM120

€ 3.117,00

Pannello portamestoli

AM4-120

€ 346,00

Disegno tecnico
e misure

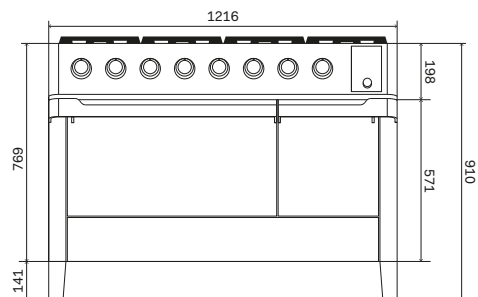
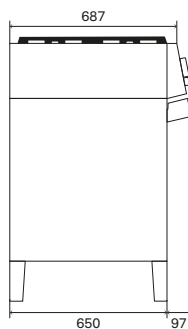

PM09



Gamma colori

Scocca



Inox - SS

Finiture



Satinato

Forni disponibili

Forno elettrico

Forno principale:
OV 80 E3 TFT S

Assorbimento massimo:
2,75 kW

Configurazioni

6 fuochi con fry top*

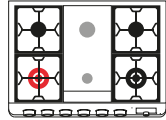

6 fuochi

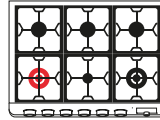

Induzione

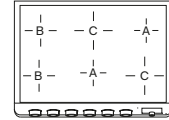

Forno elettrico

PM09FDS3

Satinato

€ 6.908,00

PM096DS3

Satinato

€ 6.442,00

PMI09S3

Satinato

€ 7.243,00

* sostituire il Fry Top con le griglie KGRFT003 (p. 316) per un uso standard dei due bruciatori

Potenze

Zona induzione
Bridge
Ø 180+180 mm
3 kW / 1,85 kW
+3 kW / 1,85 kW

Zona induzione
Ø 145 mm
2,2 kW / 1,4 kW

Zona induzione
Ø 180 mm
3 kW / 1,85 kW

Zona induzione
Ø 210 mm
3,7 kW / 2,3 kW

Bruciatore Dual
a doppia corona
5,0 kW / 0,3 kW

Bruciatore
a doppia corona
4,3 kW / 1,8 kW

Piastra Fry Top
due bruciatori
3 kW / 0,6 kW
1,8 kW / 0,4 kW

Bruciatore
grande
3 kW / 0,6 kW

Bruciatore
piccolo
1,8 kW / 0,4 kW

Complementi e accessori

→ p. 308

Cappa

APM90

€ 2.403,00

Pannello portamestoli

AM4-90

€ 254,00

Disegno tecnico e misure

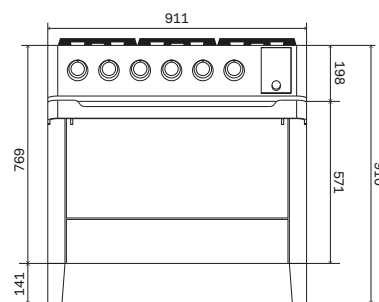
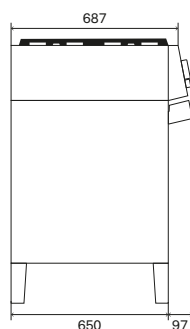

PM12

archiproducts
DESIGN AWARDS
—
WINNER 2021



Gamma colori

Scocca



Inox - SS

Finiture



Satinato

Forni disponibili

Forno elettrico

Forno principale:
OV 80 E3 TFT S

Forno secondario:
OV 30 E3 TFT

Assorbimento massimo:
2,75 kW

Assorbimento massimo:
2,4 kW

Configurazioni

8 fuochi

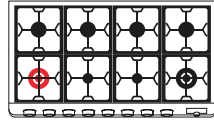

8 fuochi con fry top*

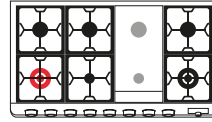

Induzione

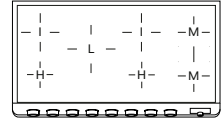

Forno elettrico

PM128DS3

Satinato

€ 13.221,00

PM12FDS3

Satinato

€ 13.689,00

PMI127S3

Satinato

€ 14.834,00

* sostituire il Fry Top con le griglie KGRFT003 (p. 316) per un uso standard dei due bruciatori

Potenze

 Zona induzione
Bridge
210x380 mm
1,5+1,5 kW

 Zona induzione
Ø 145 mm
1,85 kW / 1,4
kW

 Zona induzione
Ø 200 mm
3,0 kW / 2,3 kW

 Zona induzione
Ø 250 mm
3,0 kW / 2,3 kW

 Zona induzione
210x190 mm
3,0 kW / 2,1 kW

 Bruciatore Dual
a doppia corona
5,0 kW / 0,3 kW

 Bruciatore
a doppia corona
4,3 kW / 1,8 kW

 Piastra Fry Top
due bruciatori
3 kW / 0,6 kW
1,8 kW / 0,4 kW

 Bruciatore
grande
3 kW / 0,6 kW

 Bruciatore
piccolo
1,8 kW / 0,4 kW

Complementi
e accessori

Cappa

APM120

€ 3.117,00

Pannello portamestoli

AM4-120

€ 346,00

→ p. 308

Disegno tecnico
e misure

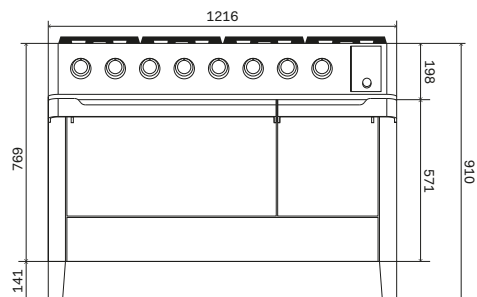
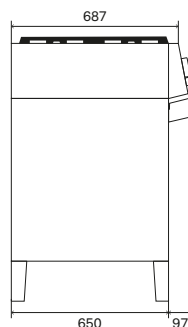

Nostalgie

I blocchi cottura Nostalgie integrano tecnologie altamente professionali e materiali di eccellenza con uno stile classico che non smette mai di emozionare. Protagonisti indiscussi della cucina, offrono una scelta completa di dimensioni (da 60 cm a 150 cm) e svariate configurazioni: è possibile scegliere il piano a induzione filo top fino a 7 zone cottura con funzione bridge per la versione da 120 cm, forno singolo o doppio, colori standard o tonalità RAL su richiesta, diverse finiture e accessori.

Disponibili come optional solo per la collezione Nostalgie, le cornici Noblesse sono più di un dettaglio: un segno grafico prezioso che incornicia i frontali, intonandosi alle finiture metalliche delle maniglie e delle manopole. La porta cieca ispirata al passato è un altro optional che arricchisce con eleganza lo stile di Nostalgie.

Gamma colori

Scocca



Bianco - WH



Bianco
antico - AW



Inox - SS



Grafite
mat - MG



Nero
lucido - BK



Blu - MB



Rosso
Borgogna - BU



Verde
smeraldo - EG



RAL
Ral Classic
opzionale - RA
+ € 800,00

Finiture

Manopole, maniglie, piedini, cornici (optional)



Ottone - G



Cromo - C



Brunito - B



Rame - P



Bruciatori opzionali Dual a gas con potenza fino a 5 kW



Spartifiamma in ottone Total Black con trattamento nanotecnologico antiaderente



Piani cottura ad alta specializzazione



Piano cottura con griglie in ghisa



Controllo unico dei due forni



Controllo elettronico della temperatura puntuale



Porta e cassetto con sistema soft closing



Porta fredda con triplo vetro estraibile



Scarico vapore



Quick start



↑ P15SNE3/MGP
Blocco cottura Nostalgie da 150 cm
Scocca Grafite mat e finiture Rame

Abaco colori e finiture



Bianco
antico - AW



Bianco - WH



Inox - SS



Grafite
mat - MG



Cromo - C



Ottone - G



Rame - P





Brunito - B



↓ Modelli rappresentati
con cornici Noblesse opzionali

 Nero
lucido - BK

 Blu - MB

 Verde
smeraldo - EG

 Rosso
Borgogna - BU



 Cromo - C



 Ottone - G



 Rame - P



 Brunito - B

OV40 E3

Midi forno elettronico statico da 40 cm

A+

5

30-250°C

elettronico

Si

-

Luce interna

Si

Porta fredda a triplo vetro
(EN60335-2-6-11.101)

tangenziale di raffreddamento

Si

con smalto easy clean

36,5×35,5×44 cm

57 L

Si

-

Si

con sonda elettronica

2,6 kW

850 W

950 W

1600 W

-

-

OV30 E3

Mini forno elettronico statico da 30 cm

A+

5

30-250°C

elettronico

Si

-

Luce interna

Si

Porta fredda a triplo vetro
(EN60335-2-6-11.101)

tangenziale di raffreddamento

Si

con smalto easy clean

27,5×35,5×44 cm

43 L

Si

-

Si

con sonda elettronica

2,4 kW

800 W

800 W

1500 W

-

-



P06N



Gamma colori

Scocca



Bianco
antico - AW



Bianco - WH



Blu - MB



Inox - SS



Grafite mat - MG



Nero lucido - BK



Rosso
Borgogna - BU



Verde
smeraldo - EG



RAL
Ral Classic - RA
optional + € 800

Finiture

Manopole, maniglie, cornici (optional)



Ottone - G



Rame - P



Cromo - C



Brunito - B

Versione porta cieca optional

optional + € 400,00

Codice ordine: aggiungere la lettera "Q" prima della "N"

Cornici Noblesse

optional → p. 311

Forni disponibili

Forno elettrico

Forno principale:
OV 60 E3

Assorbimento massimo:
2,45 kW

Configurazioni

4 fuochi

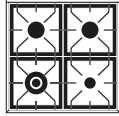

Induzione

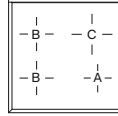

Forno elettrico

P06NE3 *

Ottone/Cromo € 2.961,00

Rame/Brunito € 3.123,00

PI064NE3

Ottone/Cromo € 3.986,00

Rame/Brunito € 4.110,00

Potenze

 Zona induzione
Bridge
Ø 180+180 mm
3 kW / 1,85 kW
+3 kW / 1,85 kW

 Zona induzione
Ø 145 mm
2,2 kW / 1,4 kW

 Zona induzione
Ø 180 mm
3 kW / 1,85 kW

 Zona induzione
Ø 210 mm
3,7 kW / 2,3 kW

 Bruciatore
a doppia corona
4,3 kW / 1,8 kW

 Bruciatore
grande
3 kW / 0,6 kW

 Bruciatore
piccolo
1,8 kW / 0,4 kW

*  Bruciatore Dual
a doppia corona
5,0 kW / 0,3 kW
optional + € 152

Complementi
e accessori

→ p. 308

Cappa

AG60

€ 1.368,00

Pannello portamestoli

AP4-60

€ 188,00

Disegno tecnico
e misure

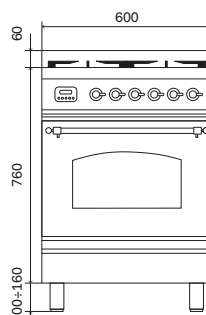
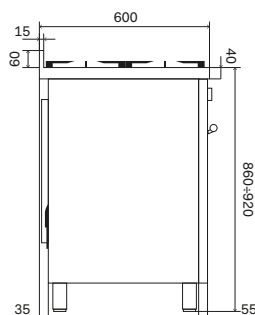

P07N



Gamma colori

Scocca



Bianco
antico - AW



Bianco - WH



Blu - MB



Inox - SS



Grafite mat - MG



Nero lucido - BK



Rosso
Borgogna - BU



Verde
smeraldo - EG



RAL
Ral Classic - RA
optional + € 800

Finiture

Manopole, maniglie, cornici (optional)



Ottone - G



Rame - P



Cromo - C



Brunito - B

Versione porta cieca optional

optional + € 400,00

Codice ordine: aggiungere la lettera "Q" prima della "N"

Cornici Noblesse

optional → p. 311

Forni disponibili

Forno elettrico

Forno principale:

OV 60 E3

Assorbimento massimo:

2,45 kW

Configurazioni

4 fuochi

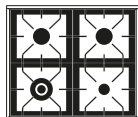

Forno elettrico

P07NE3 *

Ottone/Cromo € 2.961,00

Rame/Brunito € 3.123,00

Potenze

 Bruciatore a doppia corona
4,3 kW / 1,8 kW

 Bruciatore grande
3 kW / 0,6 kW

 Bruciatore piccolo
1,8 kW / 0,4 kW

*  Bruciatore Dual a doppia corona
5,0 kW / 0,3 kW
optional + € 152

Complementi e accessori

→ p. 308

Cappa

AG70

€ 1.431,00

Pannello portamestoli

AP4-70

€ 194,00

Disegno tecnico e misure

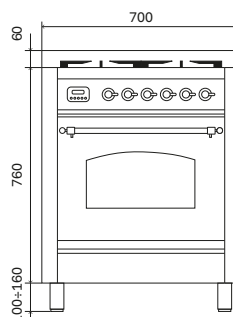
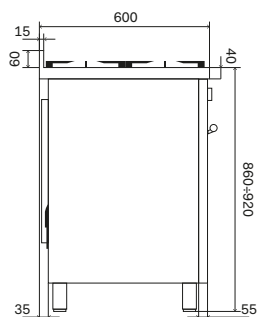

P09N



Gamma colori

Scocca



Bianco
antico - AW



Bianco - WH



Blu - MB



Inox - SS



Grafite mat - MG



Nero lucido - BK



Rosso
Borgogna - BU



Verde
smeraldo - EG



RAL
Ral Classic - RA
optional + € 800

Finiture

Manopole, maniglie, cornici (optional)



Ottone - G



Rame - P



Cromo - C



Brunito - B

Versione porta cieca optional

optional + € 400,00

Codice ordine: aggiungere la lettera "Q" prima della "N"

Cornici Noblesse

optional → p. 311

Forni disponibili

Forno elettrico

Forno principale:
OV 80 E3

Assorbimento massimo:
2,75 kW

Configurazioni

6 fuochi con fry top*

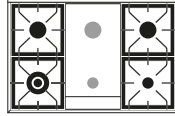

6 fuochi

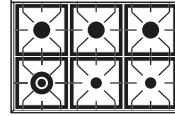

Pescera

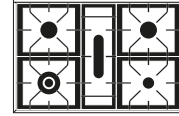

Forno elettrico

P09FNE3 *

Ottone/Cromo € 4.241,00
Rame/Brunito € 4.392,00

P096NE3 *

Ottone/Cromo € 3.915,00
Rame/Brunito € 4.038,00

P09PNE3 *

Ottone/Cromo € 3.903,00
Rame/Brunito € 3.957,00

2 zone induzione

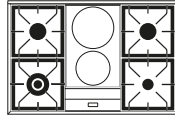

Induzione

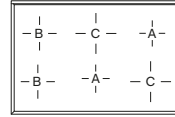

Forno elettrico

P09INE3 *

Ottone/Cromo € 4.069,00
Rame/Brunito € 4.220,00

PI096NE3

Ottone/Cromo € 5.017,00
Rame/Brunito € 5.140,00

* sostituire il Fry Top con le griglie KGRFT002 (p. 316) per un uso standard dei due bruciatori

Potenze

Zona induzione Bridge
 Ø 180+180 mm
 3 kW / 1,85 kW
 +3 kW / 1,85 kW

Zona induzione
 Ø 145 mm
 2,2 kW / 1,4 kW

Zona induzione
 Ø 180 mm
 3 kW / 1,85 kW

Zona induzione
 Ø 210 mm
 3,7 kW / 2,3 kW

Induzione
 a due zone
 2x1,85 kW
 max. 3,7 kW

Bruciatore
 a doppia corona
 4,3 kW / 1,8 kW

Piastra Fry Top
 due bruciatori
 3 kW / 0,6 kW
 1,8 kW / 0,4 kW

Pescera
 3,1 kW / 1,1 kW

Bruciatore
 grande
 3 kW / 0,6 kW

Bruciatore
 piccolo
 1,8 kW / 0,4 kW

Bruciatore Dual
 a doppia corona
 5,0 kW / 0,3 kW
 optional + € 152

Complementi
e accessori

→ p. 308

Cappa

AG90

€ 1.476,00

Cappa

ANB90

Ottone/Cromo € 3.055,00

Rame/Brunito € 3.360,00

Pannello portamestoli

AP4-90

€ 254,00

Disegno tecnico
e misure

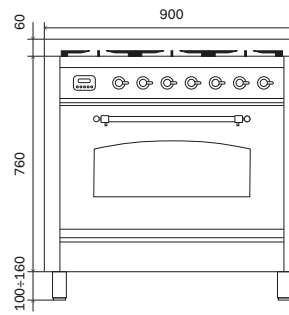
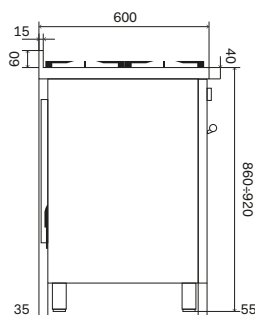

PD09N



Gamma colori

Scocca



Bianco
antico - AW



Bianco - WH



Blu - MB



Inox - SS



Grafite mat - MG



Nero lucido - BK



Rosso
Borgogna - BU



Verde
smeraldo - EG



RAL
Ral Classic - RA
optional + € 800

Finiture

Manopole, maniglie, cornici (optional)



Ottone - G



Rame - P



Cromo - C



Brunito - B

Versione porta cieca optional

optional + € 400,00

Codice ordine: aggiungere la lettera "Q" prima della "N"

Cornici Noblesse

optional → p. 311

Forni disponibili

Forno elettrico

Forno principale:
OV 60 E3

Forno secondario:
OV 30 E3

Assorbimento massimo:
2,45 kW

Assorbimento massimo:
2,4 kW

Configurazioni

6 fuochi con fry top*

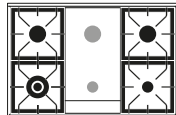

6 fuochi

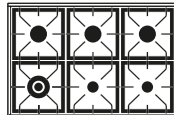

Pescera

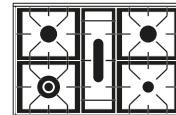

Forno elettrico

PD09FNE3 *

Ottone/Cromo € 5.078,00
Rame/Brunito € 5.254,00

PD096NE3 *

Ottone/Cromo € 4.730,00
Rame/Brunito € 4.913,00

PD09PNE3 *

Ottone/Cromo € 4.741,00
Rame/Brunito € 4.831,00

2 zone induzione

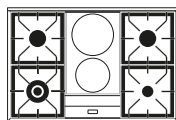

Induzione

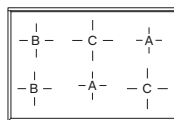

Forno elettrico

PD09INE3 *

Ottone/Cromo € 5.346,00
Rame/Brunito € 5.516,00

PDI096NE3

Ottone/Cromo € 5.810,00
Rame/Brunito € 5.974,00

* sostituire il Fry Top con le griglie KGRFT002 (p. 316) per un uso standard dei due bruciatori

Potenze

Zona induzione
Bridge
Ø 180+180 mm
3 kW / 1,85 kW
+3 kW / 1,85 kW

Zona induzione
Ø 145 mm
2,2 kW / 1,4 kW

Zona induzione
Ø 180 mm
3 kW / 1,85 kW

Zona induzione
Ø 210 mm
3,7 kW / 2,3 kW

Induzione
a due zone
2x1,85 kW
max. 3,7 kW

Bruciatore
a doppia corona
4,3 kW / 1,8 kW

Piastra Fry Top
due bruciatori
3 kW / 0,6 kW
1,8 kW / 0,4 kW

Pescera
3,1 kW / 1,1 kW

Bruciatore
grande
3 kW / 0,6 kW

Bruciatore
piccolo
1,8 kW / 0,4 kW

* Bruciatore Dual
a doppia corona
5,0 kW / 0,3 kW
optional + € 152

Complementi e accessori

→ p. 308

Cappa

AG90

€ 1.476,00

Cappa

ANB90

€ 3.055,00

Pannello portamestoli

AP4-90

€ 254,00

Rame/Brunito € 3.360,00

Disegno tecnico e misure

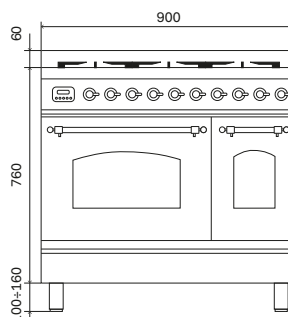
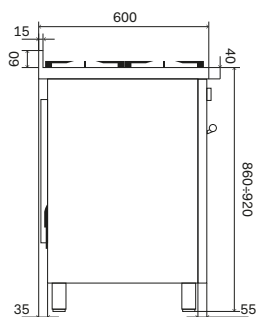

PD10N



Gamma colori

Scocca



Bianco
antico - AW



Bianco - WH



Blu - MB



Inox - SS



Grafite mat - MG



Nero lucido - BK



Rosso
Borgogna - BU



Verde
smeraldo - EG



RAL
Ral Classic - RA
optional + € 800

Finiture

Manopole, maniglie, cornici (optional)



Ottone - G



Rame - P



Cromo - C



Brunito - B

Versione porta cieca optional

optional + € 400,00

Codice ordine: aggiungere la lettera "Q" prima della "N"

Cornici Noblesse

optional → p. 311

Forni disponibili

Forno elettrico

Forno principale:
OV 60 E3

Forno secondario:
OV 40 E3

Assorbimento massimo:
2,45 kW

Assorbimento massimo:
2,6 kW

Configurazioni

6 fuochi con fry top*

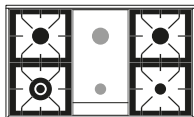

6 fuochi

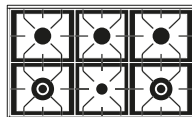

Coupe de feu

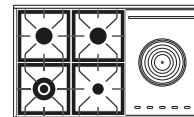

Forno elettrico

PD10FNE3 *

Ottone/Cromo € 5.303,00
Rame/Brunito € 5.573,00

PD106NE3 *

Ottone/Cromo € 4.975,00
Rame/Brunito € 5.244,00

PD10SNE3 *

Ottone/Cromo € 5.212,00
Rame/Brunito € 5.482,00

2 zone induzione

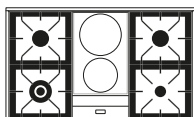

Induzione

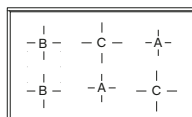

Forno elettrico

PD10INE3 *

Ottone/Cromo € 5.642,00
Rame/Brunito € 5.912,00

PD1106NE3

Ottone/Cromo € 6.176,00
Rame/Brunito € 6.312,00

* sostituire il Fry Top con le griglie KGRFT002 (p. 316) per un uso standard dei due bruciatori

Potenze

Zona induzione Bridge
Ø 180+180 mm
3 kW / 1,85 kW
+3 kW / 1,85 kW

Zona induzione
Ø 145 mm
2,2 kW / 1,4 kW

Zona induzione
Ø 180 mm
3 kW / 1,85 kW

Zona induzione
Ø 210 mm
3,7 kW / 2,3 kW

Induzione
a due zone
2x1,85 kW
max. 3,7 kW

Coup de Feu
3 kW / 0,6 kW

Bruciatore
a doppia corona
4,3 kW / 1,8 kW

Piastra Fry Top
due bruciatori
3 kW / 0,6 kW
1,8 kW / 0,4 kW

Bruciatore
grande
3 kW / 0,6 kW

Bruciatore
piccolo
1,8 kW / 0,4 kW

* Bruciatore Dual
a doppia corona
5,0 kW / 0,3 kW
optional + € 152

Complementi
e accessori

→ p. 308

Cappa

AG100

€ 1.511,00

Cappa

ANB100

Ottone/Cromo € 3.289,00

Rame/Brunito € 3.618,00

Pannello portamestoli

AP4-100

€ 282,00

Disegno tecnico
e misure

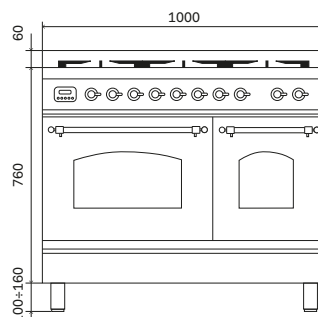
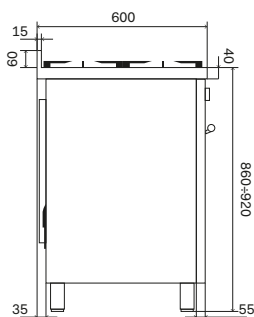

P12N



Gamma colori

Scocca



Bianco
antico - AW



Bianco - WH



Blu - MB



Inox - SS



Grafite mat - MG



Nero lucido - BK



Rosso
Borgogna - BU



Verde
smeraldo - EG



RAL
Ral Classic - RA
optional + € 800

Finiture

Manopole, maniglie, cornici (optional)



Ottone - G



Rame - P



Cromo - C



Brunito - B

Versione porta cieca optional

optional + € 400,00

Codice ordine: aggiungere la lettera "Q" prima della "N"

Cornici Noblesse

optional → p. 311

Forni disponibili

Forno elettrico

Forno principale:
OV 80 E3

Forno secondario:
OV 30 E3

Assorbimento massimo:
2,75 kW

Assorbimento massimo:
2,4 kW

Configurazioni

7 fuochi



8 fuochi con fry top*

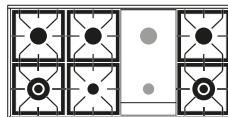

Coupe de feu

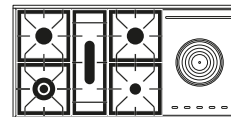

Forno elettrico

P127NE3 *

Ottone/Cromo € 10.071,00
Rame/Brunito € 10.389,00

P12FNE3 *

Ottone/Cromo € 10.071,00
Rame/Brunito € 10.389,00

P12SNE3 *

Ottone/Cromo € 10.071,00
Rame/Brunito € 10.389,00

6 fuochi con fry top* e 2 zone induzione

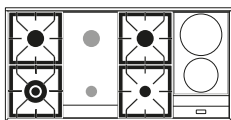

Induzione

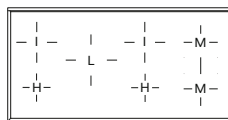

Forno elettrico

P12FINE3 *

Ottone/Cromo € 10.071,00
Rame/Brunito € 10.389,00

PI127NE3

Ottone/Cromo € 10.071,00
Rame/Brunito € 10.389,00

* sostituire il Fry Top con le griglie KGRFT002 (p. 316) per un uso standard dei due bruciatori

Potenze

—M— Zona induzione
Bridge
210x380 mm
1,5+1,5 kW

—H— Zona induzione
Ø 145 mm
1,85 kW / 1,4
kW

—L— Zona induzione
Ø 200 mm
3,0 kW / 2,3 kW

—L— Zona induzione
Ø 250 mm
3,0 kW / 2,3 kW

—M— Zona induzione
210x190 mm
3,0 kW / 2,1 kW

○ Induzione
a due zone
2x1,85 kW
max. 3,7 kW

○ Coup de Feu
3 kW / 0,6 kW

○ Bruciatore
a doppia corona
4,3 kW / 1,8 kW

○ Piastra Fry Top
due bruciatori
3 kW / 0,6 kW
1,8 kW / 0,4 kW

—H— Pescera
3,1 kW / 1,1 kW

○ Bruciatore
grande
3 kW / 0,6 kW

○ Bruciatore
piccolo
1,8 kW / 0,4 kW

* ○ Bruciatore Dual
a doppia corona
5,0 kW / 0,3 kW
optional + € 152

Complementi e accessori

→ p. 308

Cappa

AG120

€ 1.903,00

Cappa

ANB120

Ottone/Cromo € 3.525,00
Rame/Brunito € 3.876,00

Pannello portamestoli

AP4-120

€ 346,00

Disegno tecnico e misure

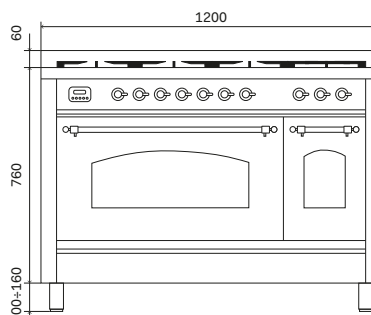
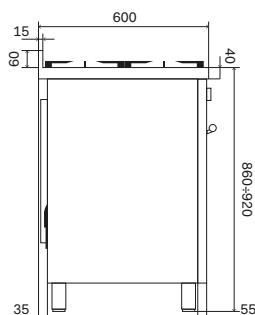

P15N



Gamma colori

Scocca



Bianco
antico - AW



Bianco - WH



Blu - MB



Inox - SS



Grafite mat - MG



Nero lucido - BK



Rosso
Borgogna - BU



Verde
smeraldo - EG



RAL
Ral Classic - RA
optional + € 800

Finiture

Manopole, maniglie, cornici (optional)



Ottone - G



Rame - P



Cromo - C



Brunito - B

Versione porta cieca optional

optional + € 400,00

Codice ordine: aggiungere la lettera "Q" prima della "N"

Cornici Noblesse

optional → p. 311

60

Forni disponibili

Forno elettrico

Forno principale:
OV 80 E3

Forno secondario:
OV 60 E3

Assorbimento massimo:
2,75 kW

Assorbimento massimo:
2,45 kW

Configurazioni

7 fuochi con fry top* e coup de feu

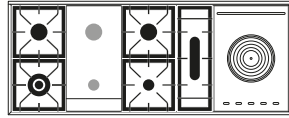

9 fuochi con fry top*

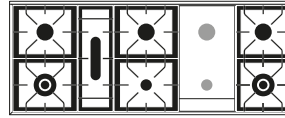

Coupe de feu

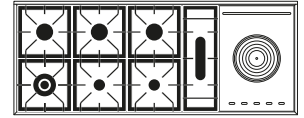

Forno elettrico

P15FSNE3 *

Ottone/Cromo € 15.124,00
Rame/Brunito € 15.461,00

P15FNE3 *

Ottone/Cromo € 15.124,00
Rame/Brunito € 15.461,00

P15SNE3 *

Ottone/Cromo € 15.124,00
Rame/Brunito € 15.461,00

* sostituire il Fry Top con le griglie KGRFT002 (p. 316) per un uso standard dei due bruciatori

Potenze



Coup de Feu
3 kW / 0,6 kW



Bruciatore a doppia corona
4,3 kW / 1,8 kW



Piastra Fry Top due bruciatori
3 kW / 0,6 kW
1,8 kW / 0,4 kW



Pescera
3,1 kW / 1,1 kW



Bruciatore grande
3 kW / 0,6 kW



Bruciatore piccolo
1,8 kW / 0,4 kW



* Bruciatore Dual a doppia corona
5,0 kW / 0,3 kW
optional + € 152

Complementi e accessori

→ p. 308

Cappa

AG150

€ 2.188,00

Cappa

ANB150

Ottone/Cromo € 3.995,00

Rame/Brunito € 4.393,00

Pannello portamestoli

AP4-150

€ 417,00

Disegno tecnico e misure

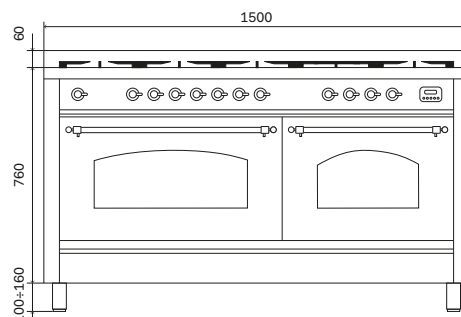
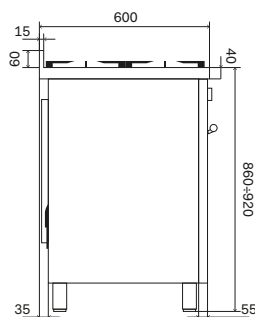

P36N

WITH
Pyrolytic
OVEN



Gamma colori

Scocca



Bianco
antico - AW



Bianco - WH



Blu - MB



Inox - SS



Grafite mat - MG



Nero lucido - BK



Rosso
Borgogna - BU



Verde
smeraldo - EG



RAL
Ral Classic - RA
optional + € 800

Finiture

Manopole, maniglie, cornici (optional)



Ottone - G



Rame - P



Cromo - C



Brunito - B

Versione porta cieca optional

optional + € 400,00

Codice ordine: aggiungere la lettera "Q" prima della "N"

Cornici Noblesse

optional → p. 311

Forni disponibili

Forno elettrico

Forno principale:
OV 80 PY TFT S

Cassetto riscaldato:
WD

Assorbimento massimo:
3,65 kW

Assorbimento massimo:
0,6 kW

Configurazioni

6 fuochi con fry top*

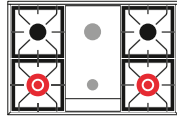

6 fuochi

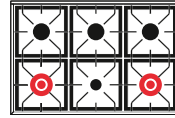

Induzione

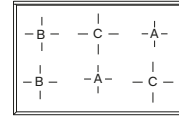

Forno elettrico

P36FDDNSY

Ottone/Cromo € 6.067,00
Rame/Brunito € 6.219,00

P366DDNSY

Ottone/Cromo € 5.755,00
Rame/Brunito € 5.905,00

PI366NSY

Ottone/Cromo € 6.447,00
Rame/Brunito € 6.599,00

* sostituire il Fry Top con le griglie KGRFT002 (p. 316) per un uso standard dei due bruciatori

Potenze

Zona induzione
Bridge
Ø 180+180 mm
3 kW / 1,85 kW
+3 kW / 1,85 kW

Zona induzione
Ø 145 mm
2,2 kW / 1,4 kW

Zona induzione
Ø 180 mm
3 kW / 1,85 kW

Zona induzione
Ø 210 mm
3,7 kW / 2,3 kW

Bruciatore Dual
a doppia corona
5,0 kW / 0,3 kW

Piastra Fry Top
due bruciatori
3 kW / 0,6 kW
1,8 kW / 0,4 kW

Bruciatore
grande
3 kW / 0,6 kW

Bruciatore
piccolo
1,8 kW / 0,4 kW

Disegno tecnico
e misure

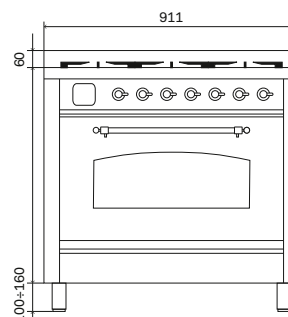
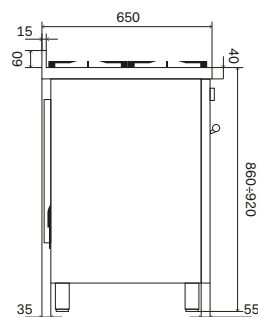
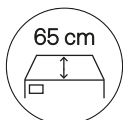

Professional Plus

I blocchi cottura Professional Plus si ispirano alle cucine dei migliori ristoranti, portando nello spazio domestico grandi doti di robustezza, ergonomia e operatività.

Offrono diverse opzioni di allestimento, dal doppio forno ai piani cottura a gas o a induzione.

I piani cottura a gas disponibili vanno da 60 cm fino a 150 cm con un massimo di 8 fuochi e possono essere integrati con coup de feu e piastra fry top.

I piani cottura a induzione sono filo top, da 90 cm fino a 120 cm: quest'ultima versione è dotata di ben 7 zone cottura e della funzione bridge.

La possibilità di scegliere diverse dimensioni, colori standard o su richiesta e finiture metalliche, consente un perfetto inserimento in ogni contesto d'arredo.

Gamma colori

Scocca



Bianco - WH



Inox - SS



Grafite
mat - MG



Nero
lucido - BK



RAL
Ral Classic
opzionale - RA
+ € 800,00

Finiture

Manopole, maniglie



Satinato



Bruciatori a gas Dual con potenza fino a 5 kW opzionali



Spartifiamma in ottone Total Black con trattamento nanotecnologico antiaderente



Piani cottura ad alta specializzazione



Piano cottura con griglie in ghisa



Controllo unico dei due forni



Controllo elettronico della temperatura puntuale



Porta e cassetto con sistema soft closing



Porta fredda con triplo vetro estraibile



Scarico vapore



↑ P15FWE3/SS
Blocco cottura Professional Plus da 150 cm
Scocca Inox e finiture Satinato

Abaco colori e finiture



Bianco - WH



Inox - SS



Grafite
mat - MG

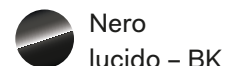

Nero
lucido - BK



Satinato



Manopole Professional: visibilmente funzionali.

Create in esclusiva per i blocchi Professional Plus, le manopole sono interamente in alluminio con diametro maggiorato e una grafica particolarmente chiara e leggibile. Grazie alla speciale zigrinatura, derivata dall'esperienza nella cucina professionale, trasmettono una piacevole sensazione di controllo e possono essere utilizzate facilmente anche con i guanti.



Forni disponibili per blocchi cottura Professional Plus

Caratteristiche generali

	OV80 PY TFT S	OV80 E3	OV60 E3
	Forno pirolitico da 80 cm	Forno elettronico da 80 cm	Forno elettronico da 60 cm
Classe energetica	A	A+	A+
Numero funzioni	15	15	15
Temperatura di esercizio	30-320°C	30-300°C	30-300°C
Programmatore	touch control TFT	elettronico	elettronico
Controllo elettronico della temperatura	Si	Si	Si
Sonda di cottura	Si	-	-
Illuminazione	Doppia luce interna	Doppia luce interna	Doppia luce interna
Chiusura porta soft-closing	Si	Si	Si
Vetri porta	Porta fredda a quattro vetri (EN60335-2-6-11.101)	Porta fredda a triplo vetro (EN60335-2-6-11.101)	Porta fredda a triplo vetro (EN60335-2-6-11.101)
Ventilazione	tangenziale di raffreddamento	tangenziale di raffreddamento	tangenziale di raffreddamento
Sicurezza bambini	Si	Si	Si

Caratteristiche cavità

Muffola	con smalto easy clean	con smalto easy clean	con smalto easy clean
Dimensioni interne	64,5×36,5×41 cm	64,5×36,5×41 cm	43,7×36×41 cm
Capacità	97 L	97 L	65 L
Scarico vapori	a comando con opzione cottura a secco o umida	a comando con opzione cottura a secco o umida	a comando con opzione cottura a secco o umida
Resistenza grill abbattibile	Si	Si	Si
Girarrosto	-	diagonale	-
Termostato	con sonda elettronica	con sonda elettronica	con sonda elettronica

Consumi

Assorbimento massimo	3,65 kW	2,75 kW	2,45 kW
Resistenza elettrica superiore	1200 W	1200 W	1000 W
Resistenza elettrica inferiore	1350 W	1350 W	1100 W
Grill elettrico	2150 W	2150 W	2100 W
Resistenza circolare	2100 W	2100 W	2100 W
Brucciato inferiore a gas	-	3,70 kW	2,70 kW

Funzioni

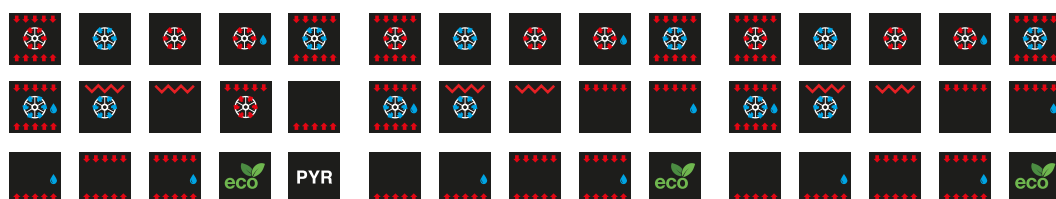

OV40 E3

Midi forno elettronico statico da 40 cm

A+

5

30-250°C

elettronico

Si

-

Luce interna

Si

Porta fredda a triplo vetro
(EN60335-2-6-11.101)

tangenziale di raffreddamento

Si

con smalto easy clean

36,5×35,5×44 cm

57 L

Si

-

Si

con sonda elettronica

2,6 kW

850 W

950 W

1600 W

-

-



OV30 E3

Mini forno elettronico statico da 30 cm

A+

5

30-250°C

elettronico

Si

-

Luce interna

Si

Porta fredda a triplo vetro
(EN60335-2-6-11.101)

tangenziale di raffreddamento

Si

con smalto easy clean

27,5×35,5×44 cm

43 L

Si

-

Si

con sonda elettronica

2,4 kW

800 W

800 W

1500 W

-

-



P06W



Gamma colori

Scocca



Bianco - WH



Inox - SS



Grafite mat - MG



Nero lucido - BK



RAL

Ral Classic - RA
optional + € 800



Satinato

Finiture

Manopole, maniglie

Forni disponibili

Forno elettrico

Forno principale:
OV 60 E3

Assorbimento massimo:
2,45 kW

Configurazioni

4 fuochi

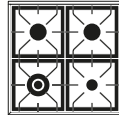

Induzione

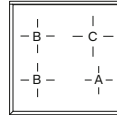

Forno elettrico

P06WE3 *

Satinato

€ 2.948,00

PI064WE3

Satinato

€ 4.034,00

Potenze

 Zona induzione
Bridge
Ø 180+180 mm
3 kW / 1,85 kW
+3 kW / 1,85 kW

 Zona induzione
Ø 145 mm
2,2 kW / 1,4 kW

 Zona induzione
Ø 180 mm
3 kW / 1,85 kW

 Zona induzione
Ø 210 mm
3,7 kW / 2,3 kW

 Bruciatore
a doppia corona
4,3 kW / 1,8 kW

 Bruciatore
grande
3 kW / 0,6 kW

 Bruciatore
piccolo
1,8 kW / 0,4 kW

 * Bruciatore Dual
a doppia corona
5,0 kW / 0,3 kW
optional + € 152

Complementi
e accessori

→ p. 308

Cappa

AGQ60

€ 1.601,00

Pannello portamestoli

AP4-60

€ 188,00

Disegno tecnico
e misure

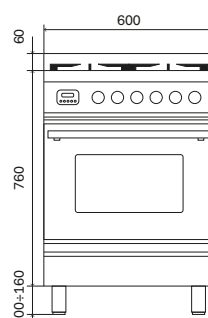
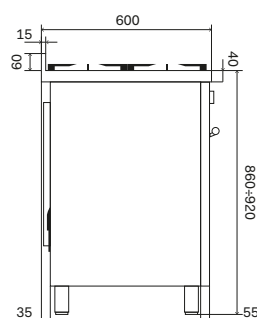

P07W



Gamma colori

Scocca



Bianco - WH



Inox - SS



Grafite mat - MG



Nero lucido - BK



Ral Classic - RA
optional + € 800

Finiture

Manopole, maniglie



Satinato

Forni disponibili

Forno elettrico

Forno principale:

OV 60 E3

Assorbimento massimo:

2,45 kW

Configurazioni

4 fuochi

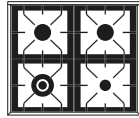

Forno elettrico

P07WE3 *

Satinato

€ 2.948,00

Potenze



Bruciatore a doppia corona
4,3 kW / 1,8 kW



Bruciatore grande
3 kW / 0,6 kW



Bruciatore piccolo
1,8 kW / 0,4 kW



* Bruciatore Dual a doppia corona
5,0 kW / 0,3 kW
optional + € 152

Complementi e accessori

Cappa

AGQ70

€ 1.633,00

Pannello portamestoli

AP4-70

€ 194,00

→ p. 308

Disegno tecnico e misure

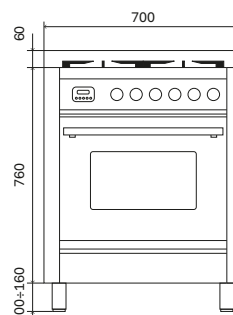
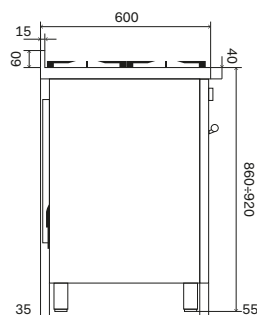

P09W



Gamma colori

Scocca



Bianco - WH



Inox - SS



Grafite mat - MG



Nero lucido - BK



Ral Classic - RA
optional + € 800

Finiture

Manopole, maniglie



Satinato

Forni disponibili

Forno elettrico

Forno principale:
OV 80 E3

Assorbimento massimo:
2,75 kW

Configurazioni

6 fuochi con fry top**

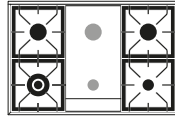

6 fuochi

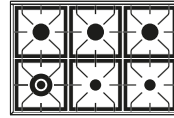

Pescera

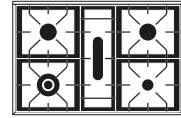

Forno elettrico

P09FWE3 *

Satinato

€ 4.200,00

P096WE3 *

Satinato

€ 3.886,00

P09PWE3 *

Satinato

€ 3.849,00

2 zone induzione

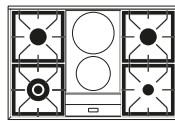

Induzione

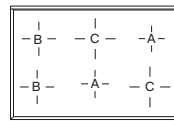

Forno elettrico

P09IWE3 *

Satinato

€ 4.028,00

PI096WE3

Satinato

€ 4.987,00

* sostituire il Fry Top con le griglie KGRFT002 (p. 316) per un uso standard dei due bruciatori

Potenze

<p>Zona induzione Bridge Ø 180+180 mm 3 kW / 1,85 kW +3 kW / 1,85 kW</p>	<p>Zona induzione Ø 145 mm 2,2 kW / 1,4 kW</p>	<p>Zona induzione Ø 180 mm 3 kW / 1,85 kW</p>	<p>Zona induzione Ø 210 mm 3,7 kW / 2,3 kW</p>	<p>Induzione a due zone 2x1,85 kW max. 3,7 kW</p>	<p>Bruciatore a doppia corona 4,3 kW / 1,8 kW</p>
<p>Piastra Fry Top due bruciatori 3 kW / 0,6 kW 1,8 kW / 0,4 kW</p>	<p>Pescera 3,1 kW / 1,1 kW</p>	<p>Bruciatore grande 3 kW / 0,6 kW</p>	<p>Bruciatore piccolo 1,8 kW / 0,4 kW</p>	<p>* Bruciatore Dual a doppia corona 5,0 kW / 0,3 kW optional + € 152</p>	

Complementi e accessori

→ p. 308

Cappa

AGQ90

€ 1.762,00

Pannello portamestoli

AP4-90

€ 254,00

Disegno tecnico e misure

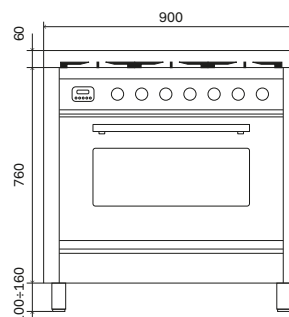
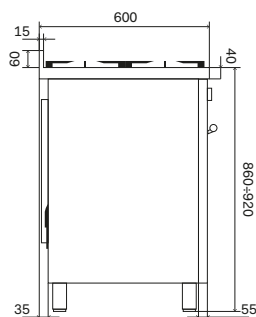

PD09W



Gamma colori

Scocca



Bianco - WH



Inox - SS



Grafite mat - MG



Nero lucido - BK



RAL

Ral Classic - RA
optional + € 800

Finiture

Manopole, maniglie



Satinato

Forni disponibili

Forno elettrico

Forno principale:
OV 60 E3

Forno secondario:
OV 30 E3

Assorbimento massimo:
2,45 kW

Assorbimento massimo:
2,4 kW

Configurazioni

6 fuochi con fry top**

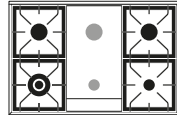

6 fuochi

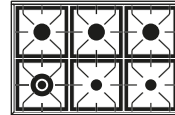

Pescera

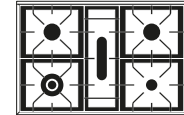

Forno elettrico

PD09FWE3 *

Satinato € 5.020,00

PD096WE3 *

Satinato € 4.687,00

PD09PWE3 *

Satinato € 4.674,00

2 zone induzione

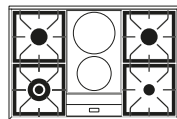

Induzione

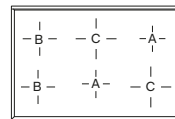

Forno elettrico

PD09IWE3 *

Satinato € 5.297,00

PDI096WE3

Satinato € 5.751,00

* sostituire il Fry Top con le griglie KGRFT002 (p. 316) per un uso standard dei due bruciatori

Potenze

Zona induzione Bridge
Ø 180+180 mm
3 kW / 1,85 kW
+3 kW / 1,85 kW

Zona induzione
Ø 145 mm
2,2 kW / 1,4 kW

Zona induzione
Ø 180 mm
3 kW / 1,85 kW

Zona induzione
Ø 210 mm
3,7 kW / 2,3 kW

Induzione
a due zone
2x1,85 kW
max. 3,7 kW

Bruciatore
a doppia corona
4,3 kW / 1,8 kW

Piastra Fry Top
due bruciatori
3 kW / 0,6 kW
1,8 kW / 0,4 kW

Pescera
3,1 kW / 1,1 kW

Bruciatore
grande
3 kW / 0,6 kW

Bruciatore
piccolo
1,8 kW / 0,4 kW

* Bruciatore Dual
a doppia corona
5,0 kW / 0,3 kW
optional + € 152

Complementi
e accessori

Cappa

AGQ90

€ 1.762,00

Pannello portamestoli

AP4-90

€ 254,00

→ p. 308

Disegno tecnico
e misure

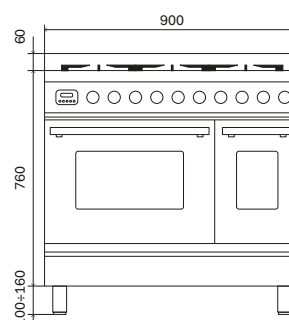
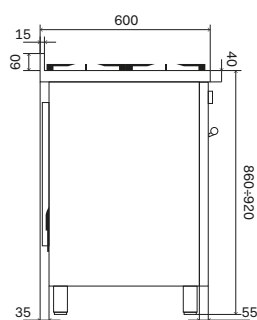

PD10W



Gamma colori

Scocca



Bianco - WH



Inox - SS



Grafite mat - MG



Nero lucido - BK



RAL

Ral Classic - RA
optional + € 800

Finiture

Manopole, maniglie



Satinato

Forni disponibili

Forno elettrico

Forno principale:
OV 60 E3

Forno secondario:
OV 40 E3

Assorbimento massimo:
2,45 kW

Assorbimento massimo:
2,6 kW

Configurazioni

6 fuochi con fry top**

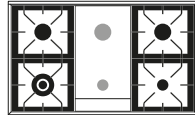

6 fuochi

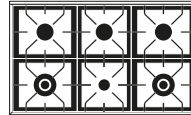

Coupe de feu

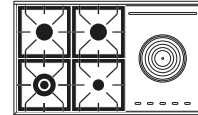

Forno elettrico

PD10FWE3 *

Satinato

€ 5.246,00

PD106WE3 *

Satinato

€ 4.916,00

PD10SWE3 *

Satinato

€ 5.155,00

2 zone induzione

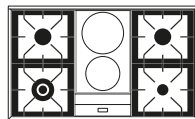

Induzione

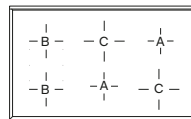

Forno elettrico

PD10IWE3 *

Satinato

€ 5.575,00

PDI106WE3

Satinato

€ 6.137,00

* sostituire il Fry Top con le griglie KGRFT002 (p. 316) per un uso standard dei due bruciatori

Potenze

Zona induzione Bridge
 Ø 180+180 mm
 3 kW / 1,85 kW
 +3 kW / 1,85 kW

Zona induzione
 Ø 145 mm
 2,2 kW / 1,4 kW

Zona induzione
 Ø 180 mm
 3 kW / 1,85 kW

Zona induzione
 Ø 210 mm
 3,7 kW / 2,3 kW

Induzione
 a due zone
 2x1,85 kW
 max. 3,7 kW

Coup de Feu
 3 kW / 0,6 kW

Bruciatore
 a doppia corona
 4,3 kW / 1,8 kW

Piastra Fry Top
 due bruciatori
 3 kW / 0,6 kW
 1,8 kW / 0,4 kW

Bruciatore
 grande
 3 kW / 0,6 kW

Bruciatore
 piccolo
 1,8 kW / 0,4 kW

* Bruciatore Dual
 a doppia corona
 5,0 kW / 0,3 kW
 optional + € 152

Complementi
e accessori

Cappa

AGQ100

€ 1.851,00

Pannello portamestoli

AP4-100

€ 282,00

→ p. 308

Disegno tecnico
e misure

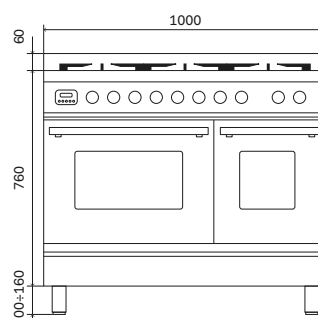
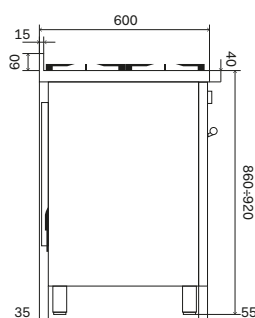

P12W



Gamma colori

Scocca



Bianco - WH



Inox - SS



Grafite mat - MG



Nero lucido - BK



RAL

Ral Classic - RA
optional + € 800

Finiture

Manopole, maniglie



Satinato

Forni disponibili

Forno elettrico

Forno principale:
OV 80 E3

Forno secondario:
OV 30 E3

Assorbimento massimo:
2,75 kW

Assorbimento massimo:
2,4 kW

Configurazioni

7 fuochi

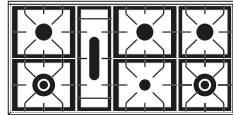

8 fuochi con fry top**

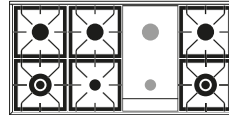

Coupe de feu

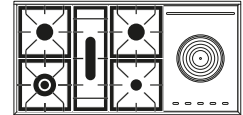

Forno elettrico

P127WE3

Satinato € 10.071,00

P12FWE3 *

Satinato € 10.071,00

P12SWE3 *

Satinato € 10.071,00

6 fuochi con fry top** e 2 zone induzione

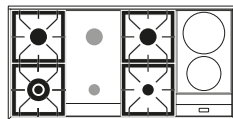

Induzione

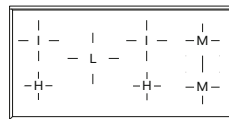

Forno elettrico

P12FIWE3 *

Satinato € 10.071,00

PI127WE3

Satinato € 10.071,00

* sostituire il Fry Top con le griglie KGRFT002 (p. 316) per un uso standard dei due bruciatori

Potenze

Zona induzione
Bridge
210x380 mm
1,5+1,5 kW

Zona induzione
Ø 145 mm
1,85 kW / 1,4
kW

Zona induzione
Ø 200 mm
3,0 kW / 2,3 kW

Zona induzione
Ø 250 mm
3,0 kW / 2,3 kW

Zona induzione
210x190 mm
3,0 kW / 2,1 kW

Induzione
a due zone
2x1,85 kW
max. 3,7 kW

Coup de Feu
3 kW / 0,6 kW

Bruciatore
a doppia corona
4,3 kW / 1,8 kW

Piastra Fry Top
due bruciatori
3 kW / 0,6 kW
1,8 kW / 0,4 kW

Pescera
3,1 kW / 1,1 kW

Bruciatore
grande
3 kW / 0,6 kW

Bruciatore
piccolo
1,8 kW / 0,4 kW

* Bruciatore Dual
a doppia corona
5,0 kW / 0,3 kW
optional + € 152

Complementi
e accessori

Cappa

AGQ120

€ 2.382,00

Pannello portamestoli

AP4-120

€ 346,00

→ p. 308

Disegno tecnico
e misure

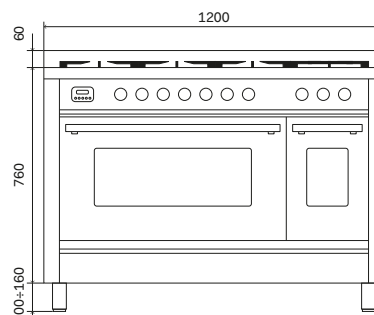
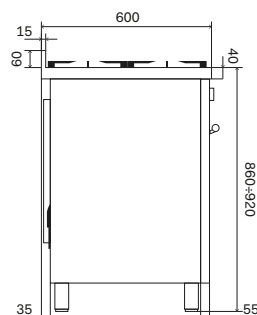

P15W



Gamma colori

Scocca



Bianco - WH



Inox - SS



Grafite mat - MG



Nero lucido - BK



RAL

Ral Classic - RA
optional + € 800

Finiture

Manopole, maniglie



Satinato

Forni disponibili

Forno elettrico

Forno principale:
OV 80 E3

Forno secondario:
OV 60 E3

Assorbimento massimo:
2,75 kW

Assorbimento massimo:
2,45 kW

Configurazioni

7 fuochi con fry top** e coup de feu

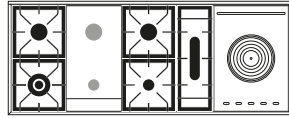

9 fuochi con fry top**

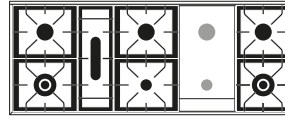

Coupe de feu

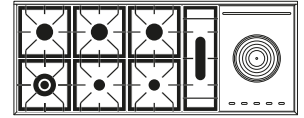

Forno elettrico

P15FSWE3 *

Satinato

€ 15.124,00

P15FWE3 *

Satinato

€ 15.124,00

P15SWE3 *

Satinato

€ 15.124,00

* sostituire il Fry Top con le griglie KGRFT002 (p. 316) per un uso standard dei due bruciatori

Potenze

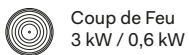

Coup de Feu
3 kW / 0,6 kW



Bruciatore
a doppia corona
4,3 kW / 1,8 kW



Piastra Fry Top
due bruciatori
3 kW / 0,6 kW
1,8 kW / 0,4 kW



Pescera
3,1 kW / 1,1 kW



Bruciatore
grande
3 kW / 0,6 kW



Bruciatore
piccolo
1,8 kW / 0,4 kW



* Bruciatore Dual
a doppia corona
5,0 kW / 0,3 kW
optional + € 152

Complementi e accessori

Cappa

AGQ150

€ 2.786,00

Pannello portamestoli

AP4-150

€ 417,00

→ p. 308

Disegno tecnico e misure

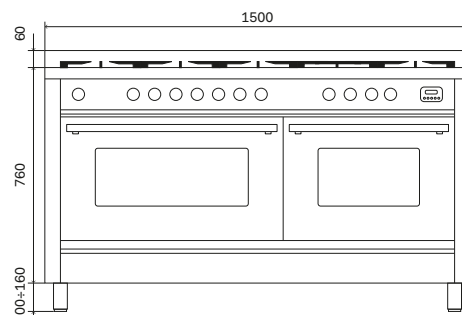
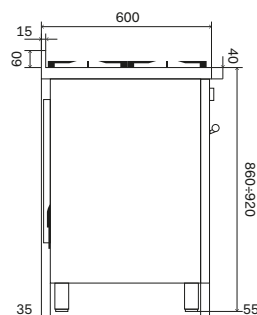

P36W

WITH
Pyrolytic
OVEN



Gamma colori

Scocca



Bianco - WH



Inox - SS



Grafite mat - MG



Nero lucido - BK



RAL

Ral Classic - RA
optional + € 800

Finiture

Manopole, maniglie



Satinato

Forni disponibili

Forno elettrico

Forno principale:
OV 80 PY TFT S

Cassetto riscaldato:
WD

Assorbimento massimo:
3,65 kW

Assorbimento massimo:
0,6 kW

Configurazioni

6 fuochi con fry top**

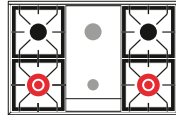

6 fuochi

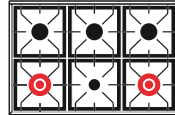

Induzione

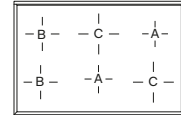

Forno elettrico

P36FDDWSY

Satinato

€ 6.027,00

P366DDWSY

Satinato

€ 5.713,00

PI366WSY

Satinato

€ 6.406,00

* sostituire il Fry Top con le griglie KGRFT002 (p. 316) per un uso standard dei due bruciatori

Potenze

Zona induzione
Bridge
Ø 180+180 mm
3 kW / 1,85 kW
+3 kW / 1,85 kW

Zona induzione
Ø 145 mm
2,2 kW / 1,4 kW

Zona induzione
Ø 180 mm
3 kW / 1,85 kW

Zona induzione
Ø 210 mm
3,7 kW / 2,3 kW

Bruciatore Dual
a doppia corona
5,0 kW / 0,3 kW

Piastra Fry Top
due bruciatori
3 kW / 0,6 kW
1,8 kW / 0,4 kW

Bruciatore
grande
3 kW / 0,6 kW

Bruciatore
piccolo
1,8 kW / 0,4 kW

Disegno tecnico
e misure

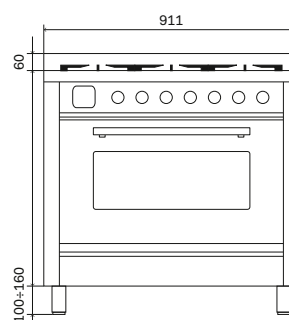
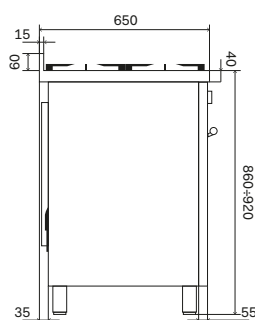
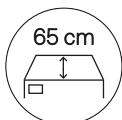

Pro Line

Pensati per un facile inserimento nell'arredamento della cucina di casa, con dimensioni che variano da 60 cm a 120 cm, i blocchi cottura Pro Line offrono prestazioni senza compromessi, concentrandosi sull'essenziale: dal piano cottura con diverse tipologie e possibili configurazioni, al forno multifunzione in versione singola o doppia con temperature che vanno dai 30° C ai 300° C. Pensati e realizzati per durare a lungo nel tempo, sono proposti in una scelta di colori che permette di creare ambienti moderni con un'estetica fresca e raffinata.

Gamma colori

Scocca



Bianco - WH



Bianco
antico - AW



Inox - SS



Grafite
mat - MG



Rosso
Borgogna - BU

Finiture

Manopole, maniglie



Satinato



Spartifiamma
in ottone con
trattamento
nanotecnologico
antiaderente



Piani cottura
ad alta
specializzazione



Bruciatori doppia
corona con
potenza fino a
4,3kW



Piano cottura
con griglie in ghisa



Porta fredda
con triplo vetro
estraibile



Porta con
sistema soft
closing



↑ LD10FWM3/MG
Blocco cottura Pro Line da 100 cm
Scocca Grafite mat e finiture Satinato

Abaco colori e finiture



Bianco
antico - AW



Bianco - WH



Inox - SS



Satinato



Grafite
mat - MG



Rosso
Borgogna - BU



Satinato



L09 Limited edition

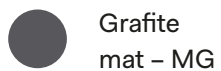

Grafite
mat - MG

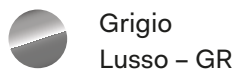

Grigio
Lusso - GR



Nero
opaco - D



OV30 E

Mini forno elettrico statico da 30 cm

A

4

50-250°C

-

-

-

Luce interna

Si

Porta fredda a triplo vetro
(EN60335-2-6-11.101)

tangenziale di raffreddamento

-

con smalto easy clean

27,5×35,5×44 cm

43 L

Si

-

Si

analogico

1,7 kW

800 W

800 W

1500 W

-

-

-



L09-GRD

ILVE
Limited Edition
Pro Line



Gamma colori

Scocca



Grigio lusso - GR

Finiture

Manopole, maniglie



Nero opaco - D

Forni disponibili

Forno elettrico

Forno principale:

OV 80 M3

Assorbimento massimo:

2,75 kW

Configurazioni

6 fuochi

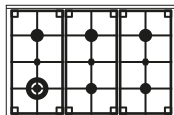

Forno elettrico

L096WM3

Nero opaco

€ 3.341,00

Potenze



Bruciatore
a doppia corona
4,3 kW / 1,8 kW



Bruciatore
grande
3 kW / 0,6 kW



Bruciatore
piccolo
1,8 kW / 0,4 kW

Complementi e accessori

→ p. 308

Cappa

AGK90

Inox

€ 748,00

Grigio Lusso

€ 949,00

Pannello portamestoli

AP4-90

€ 254,00

Disegno tecnico e misure

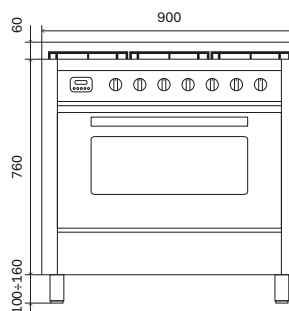
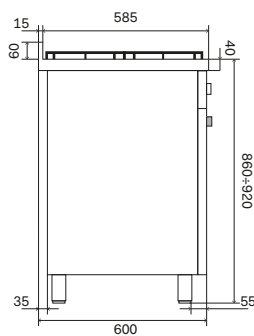

L09-MGD

ILVE
Limited Edition
Pro Line



Gamma colori

Scocca



Grafite mat - MG

Finiture

Manopole, maniglie



Nero opaco - D

Forni disponibili

Forno elettrico

Forno principale:
OV 80 M3

Assorbimento massimo:
2,75 kW

Configurazioni

6 fuochi

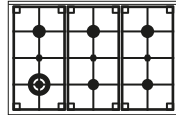

Forno elettrico

L096WM3

Nero opaco

€ 3.341,00

Potenze

 Bruciatore
a doppia corona
4,3 kW / 1,8 kW

 Bruciatore
grande
3 kW / 0,6 kW

 Bruciatore
piccolo
1,8 kW / 0,4 kW

Complementi
e accessori

→ p. 308

Cappa

AGK90

Inox

€ 748,00

Grafite mat

€ 949,00

Pannello portamestoli

AP4-90

€ 254,00

Disegno tecnico
e misure

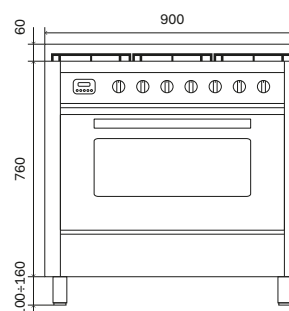
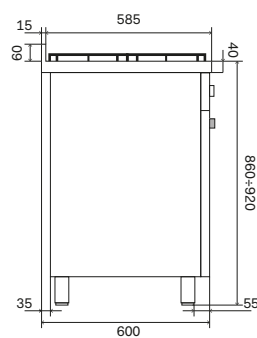

L06



Gamma colori

Scocca



Bianco
antico - AW



Bianco - WH



Inox - SS



Grafite mat - MG



Rosso
Borgogna - BU



Satinato

Finiture

Manopole, maniglie

Forni disponibili

Forno elettrico

Forno principale:
OV 60 M3

Assorbimento massimo:
2,45 kW

Configurazioni

4 fuochi

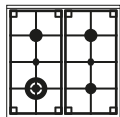

Forno elettrico

L06WM3

Satinato

€ 2.453,00

Potenze

 Bruciatore a doppia corona
4,3 kW / 1,8 kW

 Bruciatore grande
3 kW / 0,6 kW

 Bruciatore piccolo
1,8 kW / 0,4 kW

Complementi e accessori

Cappa
Inox

AGK60
€ 726,00

Pannello portamestoli

AP4-60
€ 188,00

→ p. 308

Disegno tecnico e misure

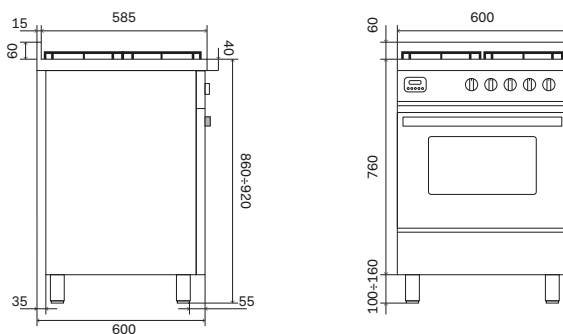

L09



Gamma colori

Scocca



Bianco
antico - AW



Bianco - WH



Inox - SS



Grafite mat - MG



Rosso
Borgogna - BU

Finiture

Manopole, maniglie



Satinato

Forni disponibili

Forno elettrico

Forno principale:
OV 80 M3

Assorbimento massimo:
2,75 kW

Configurazioni

5 fuochi

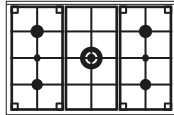

6 fuochi con fry top*

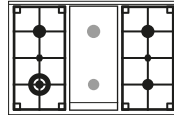

6 fuochi

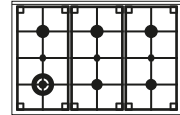

Forno elettrico

L09CWM3

Satinato € 2.940,00

L09FWM3

Satinato € 3.256,00

L096WM3

Satinato € 3.141,00

Induzione

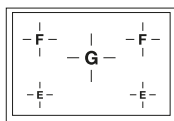

Forno elettrico

LBI09WM3

Satinato € 3.955,00

* sostituire il fry top con le griglie EA2630001000000 (p. 316) per un uso standard dei due bruciatori

Potenze

-E- Zona induzione
Ø 175 mm
2 kW / 1,4 kW

-F- Zona induzione
Ø 215 mm
3 kW / 2,3 kW

-G- Zona induzione
Ø 265 mm
3 kW / 2,3 kW

Piastra Fry Top
due bruciatori
3 kW / 0,6 kW
1,8 kW / 0,4 kW

 Bruciatore
a doppia corona
4,3 kW / 1,8 kW

 Bruciatore
grande
3 kW / 0,6 kW

 Bruciatore
piccolo
1,8 kW / 0,4 kW

Complementi
e accessori

→ p. 308

Cappa

Inox AGK90 € 748,00

Pannello portamestoli

AP4-90

€ 254,00

Disegno tecnico
e misure

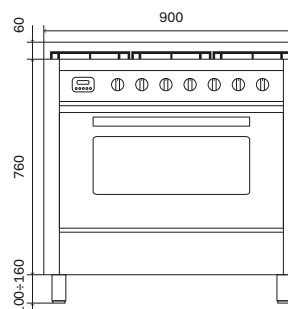
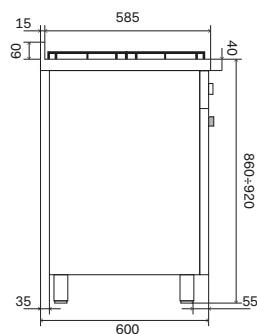

LD09



Gamma colori

Scocca



Bianco
antico - AW



Bianco - WH



Inox - SS



Grafite mat - MG



Rosso
Borgogna - BU

Finiture

Manopole, maniglie



Satinato

Forni disponibili

Forno elettrico

Forno principale:
OV 60 M3

Forno secondario:
OV 30 E

Assorbimento massimo:
2,45 kW

Assorbimento massimo:
1,7 kW

Configurazioni

5 fuochi

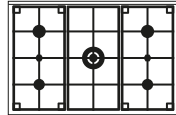

6 fuochi con fry top*

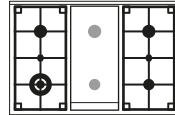

6 fuochi

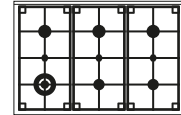

Forno elettrico

LD09CWM3

Satinato € 3.463,00

LD09FWM3

Satinato € 3.786,00

LD096WM3

Satinato € 3.670,00

Induzione

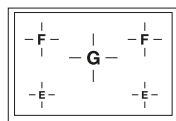

Forno elettrico

LDBI09WM3

Satinato € 4.811,00

* sostituire il fry top con le griglie EA2630001000000 (p. 316) per un uso standard dei due bruciatori

Potenze

-E- Zona induzione
Ø 175 mm
2 kW / 1,4 kW

-F- Zona induzione
Ø 215 mm
3 kW / 2,3 kW

-G- Zona induzione
Ø 265 mm
3 kW / 2,3 kW

Piastra Fry Top
due bruciatori
3 kW / 0,6 kW
1,8 kW / 0,4 kW

 Bruciatore
a doppia corona
4,3 kW / 1,8 kW

 Bruciatore
grande
3 kW / 0,6 kW

 Bruciatore
piccolo
1,8 kW / 0,4 kW

Complementi
e accessori

→ p. 308

Cappa

AGK90

Inox € 748,00

Cappa

AGK90-GR

€ 949,00

Cappa

AGK90-MG

€ 949,00

Disegno tecnico
e misure

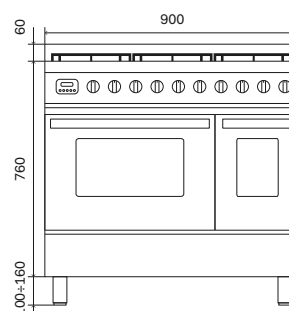
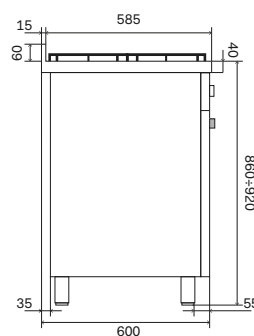

LD10



Gamma colori

Scocca



Bianco
antico - AW



Bianco - WH



Inox - SS



Grafite mat - MG



Rosso
Borgogna - BU



Satinato

Finiture

Manopole, maniglie

Forni disponibili

Forno elettrico

Forno principale:
OV 60 M3

Assorbimento massimo:
2,45 kW

Forno secondario:
OV 40 E

Assorbimento massimo:
1,9 kW

Configurazioni

5 fuochi

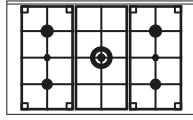

6 fuochi con fry top*

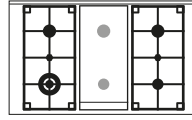

6 fuochi

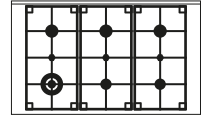

Forno elettrico

LD10CWM3

Satinato

€ 3.642,00

LD10FWM3

Satinato

€ 4.013,00

LD106WM3

Satinato

€ 3.838,00

* sostituire il fry top con le griglie EA2630001000000 (p. 316) per un uso standard dei due bruciatori

Potenze

 Bruciatore a doppia corona
4,3 kW / 1,8 kW

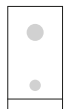
 Piastra Fry Top due bruciatori
3 kW / 0,6 kW
1,8 kW / 0,4 kW

 Bruciatore grande
3 kW / 0,6 kW

 Bruciatore piccolo
1,8 kW / 0,4 kW

Complementi e accessori

→ p. 308

Cappa

Inox

AGK100

€ 770,00

Pannello portamestoli

AP4-100

€ 282,00

Disegno tecnico e misure

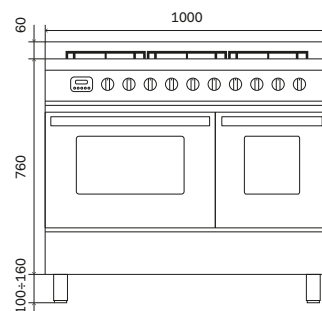
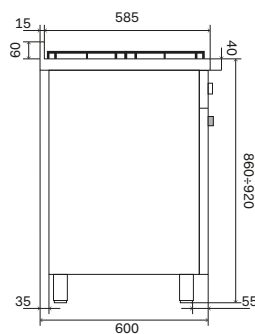

L12



Gamma colori

Scocca



Bianco
antico - AW



Bianco - WH



Inox - SS



Grafite mat - MG



Rosso
Borgogna - BU



Satinato

Finiture

Manopole, maniglie

Forni disponibili

Forno elettrico

Forno principale:
OV 80 M3

Forno secondario:
OV 30 E

Assorbimento massimo:
2,75 kW

Assorbimento massimo:
1,7 kW

Configurazioni

8 fuochi

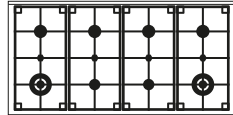

8 fuochi con fry top*

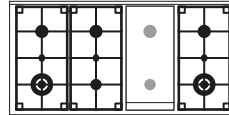

Forno elettrico

L128WM3

Satinato

€ 7.171,00

L12FWM3

Satinato

€ 7.338,00

* sostituire il fry top con le griglie EA2630001000000 (p. 316) per un uso standard dei due bruciatori

Potenze



Bruciatore
a doppia corona
4,3 kW / 1,8 kW

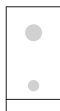

Piastra Fry Top
due bruciatori
3 kW / 0,6 kW
1,8 kW / 0,4 kW



Bruciatore
grande
3 kW / 0,6 kW



Bruciatore
piccolo
1,8 kW / 0,4 kW

Complementi e accessori

→ p. 308

Cappa

AGK120

Inox

€ 1.090,00

Pannello portamestoli

AP4-120

€ 346,00

Disegno tecnico e misure

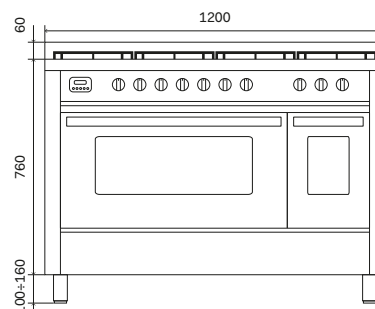
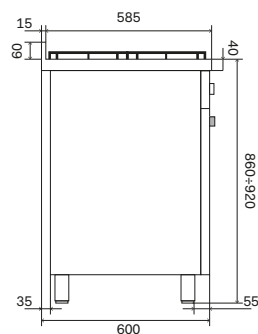

Forni disponibili

Forno elettrico

Forno principale:
OV 60 M3

Forno secondario:
OV 30 E

Assorbimento massimo:
2,45 kW

Assorbimento massimo:
1,7 kW

Configurazioni

5 fuochi

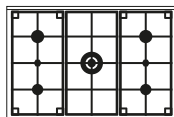

6 fuochi con fry top*

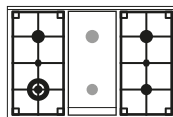

6 fuochi

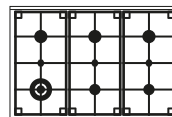

Forno elettrico

LD09CWM3

Satinato

€ 3.463,00

LD09FWM3

Satinato

€ 3.786,00

LD096WM3

Satinato

€ 3.670,00

Induzione

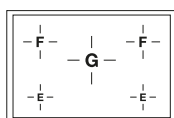

Forno elettrico

LDBI09WM3

Satinato

€ 4.811,00

* sostituire il fry top con le griglie EA2630001000000 (p. 316) per un uso standard dei due bruciatori

Potenze

—E— Zona induzione
Ø 175 mm
2 kW / 1,4 kW

—F— Zona induzione
Ø 215 mm
3 kW / 2,3 kW

—G— Zona induzione
Ø 265 mm
3 kW / 2,3 kW

 Bruciatore
a doppia corona
4,3 kW / 1,8 kW

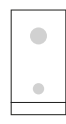
 Piastra Fry Top
due bruciatori
3 kW / 0,6 kW
1,8 kW / 0,4 kW

 Bruciatore
grande
3 kW / 0,6 kW

 Bruciatore
piccolo
1,8 kW / 0,4 kW

Complementi
e accessori

→ p. 308

Cappa

AGK90

Inox

€ 748,00

Cappa

AGK90-GR

€ 949,00

Cappa

AGK90-MG

€ 949,00

Disegno tecnico
e misure

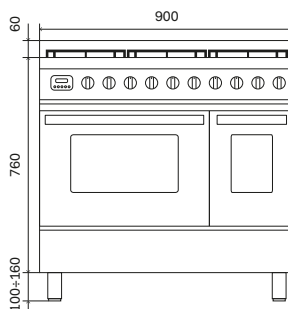
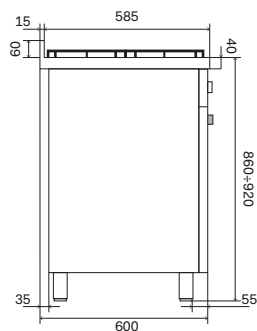

Majestic

MD10N — Elettrica

Forno principale: OV 60 E3 TFT S
Forno secondario: OV 30 E3 TFT



6 fuochi con fry top*

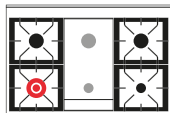

MD10FDNE3

Ottone/Cromo € 6.595,00
Rame/Brunito € 6.749,00

Majestic

M12N — Elettrica

Forno principale: OV 80 E3 TFT S
Forno secondario: OV 30 E3 TFT



7 fuochi

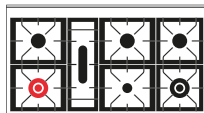

M127DNE3

Ottone/Cromo € 11.923,00
Rame/Brunito € 12.797,00

Majestic

M15N — Elettrica

Forno principale: OV 80 E3 TFT S
Forno secondario: OV 60 E3 TFT



7 fuochi con fry top* e coup de feu

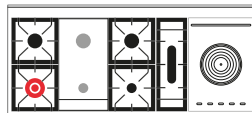

M15FSDNE3

Ottone/Cromo € 17.716,00
Rame/Brunito € 18.886,00

6 fuochi

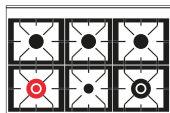

MD106DNE3

Ottone/Cromo € 6.338,00
Rame/Brunito € 6.635,00

8 fuochi con fry top*

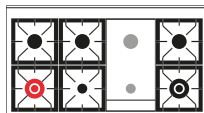

M12FDNE3

Ottone/Cromo € 11.923,00
Rame/Brunito € 12.797,00

9 fuochi con fry top*

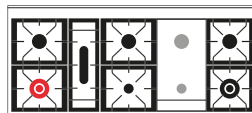

M15FDNE3

Ottone/Cromo € 17.716,00
Rame/Brunito € 18.886,00

Coupe de feu



MD10SDNE3

Ottone/Cromo € 6.504,00
Rame/Brunito € 6.796,00

Coupe de feu

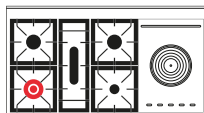

M12SDNE3

Ottone/Cromo € 11.923,00
Rame/Brunito € 12.797,00

Coupe de feu

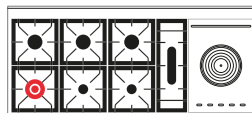

M15SDNE3

Ottone/Cromo € 17.716,00
Rame/Brunito € 18.886,00

2 zone induzione

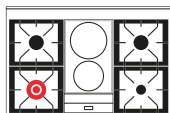

MD10IDNE3

Ottone/Cromo € 6.915,00
Rame/Brunito € 7.162,00

6 fuochi con fry top* e 2 zone induzione

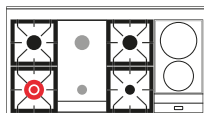

M12FIDNE3

Ottone/Cromo € 11.923,00
Rame/Brunito € 12.797,00

Induzione

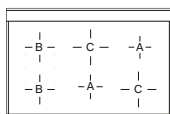

MDI106NE3

Ottone/Cromo € 7.417,00
Rame/Brunito € 7.710,00

Induzione

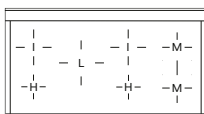

MI127NE3

Ottone/Cromo € 11.923,00
Rame/Brunito € 12.797,00

Panoramagic
PM09 — Elettrica

Forno principale: OV 80 E3 TFT S



Induzione

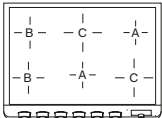

PMI09S3

Satinato € 7.243,00

Panoramagic
PM12 — Elettrica

Forno principale: OV 80 E3 TFT S
Forno secondario: OV 30 E3 TFT



Induzione

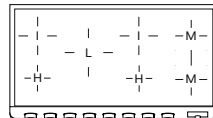

PMI127S3

Satinato € 14.834,00

Panoramagic
PM09 — Elettrica

Forno principale: OV 80 E3 TFT S



6 fuochi con fry top*

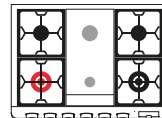

PM09FDS3

Satinato € 6.908,00

Panoramagic
PM12 — Elettrica

Forno principale: OV 80 E3 TFT S
Forno secondario: OV 30 E3 TFT



8 fuochi

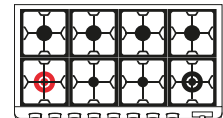

PM128DS3

Satinato € 13.221,00

6 fuochi

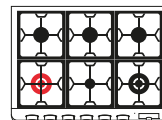

PM096DS3

Satinato € 6.442,00

8 fuochi con fry top*

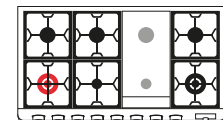

PM12FDS3

Satinato € 13.689,00

Induzione

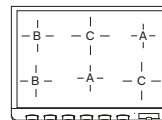

PMI09S3

Satinato € 7.243,00

Induzione

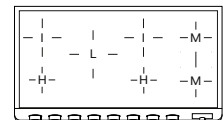

PMI127S3

Satinato € 14.834,00

Panoramagic

Mod. /mm	A	B
PM09	455	183
PM12	457	192

Vista posteriore

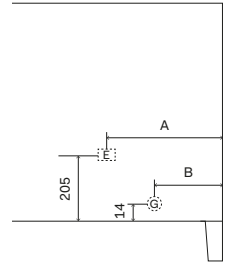

Vista laterale

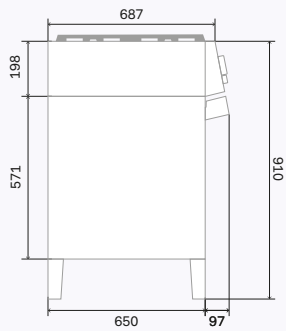

PM09

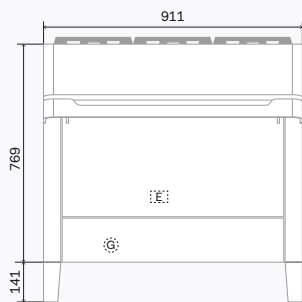

PM12

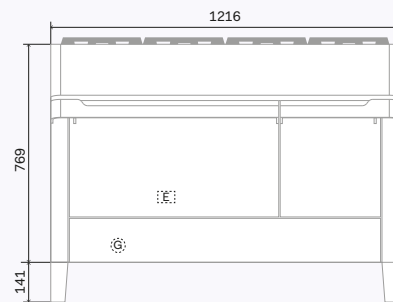

Nostalgie
P06N — Elettrica

Forno principale: OV 60 E3



4 fuochi

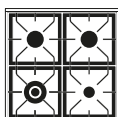

P06NE3 *

Ottone/Cromo	€ 2.961,00
Rame/Brunito	€ 3.123,00

Nostalgie
P07N — Elettrica

Forno principale: OV 60 E3



4 fuochi



P07NE3 *

Ottone/Cromo	€ 2.961,00
Rame/Brunito	€ 3.123,00

Nostalgie
P09N — Elettrica

Forno principale: OV 80 E3



6 fuochi con fry top*

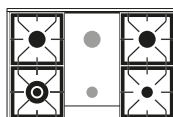

P09FNE3 *

Ottone/Cromo	€ 4.241,00
Rame/Brunito	€ 4.392,00

Nostalgie
PD09N — Elettrica

Forno principale: OV 60 E3
Forno secondario: OV 30 E3



6 fuochi con fry top*

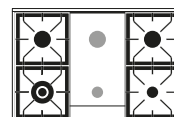

PD09FNE3 *

Ottone/Cromo	€ 5.078,00
Rame/Brunito	€ 5.254,00

Induzione

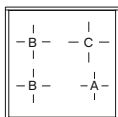

PI064NE3

Ottone/Cromo	€ 3.986,00
Rame/Brunito	€ 4.110,00

6 fuochi

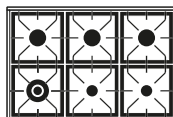

P096NE3 *

Ottone/Cromo	€ 3.915,00
Rame/Brunito	€ 4.038,00

6 fuochi

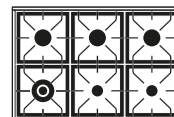

PD096NE3 *

Ottone/Cromo	€ 4.730,00
Rame/Brunito	€ 4.913,00

Pescera

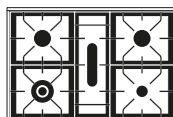

P09PNE3 *

Ottone/Cromo	€ 3.903,00
Rame/Brunito	€ 3.957,00

Pescera

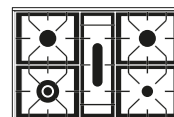

PD09PNE3 *

Ottone/Cromo	€ 4.741,00
Rame/Brunito	€ 4.831,00

2 zone induzione

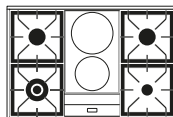

P09INE3 *

Ottone/Cromo	€ 4.069,00
Rame/Brunito	€ 4.220,00

2 zone induzione

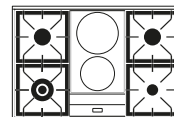

PD09INE3 *

Ottone/Cromo	€ 5.346,00
Rame/Brunito	€ 5.516,00

Induzione

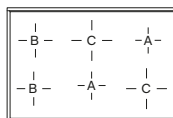

PI096NE3

Ottone/Cromo	€ 5.017,00
Rame/Brunito	€ 5.140,00

Induzione

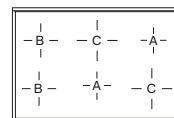

PDI096NE3

Ottone/Cromo	€ 5.810,00
Rame/Brunito	€ 5.974,00

Nostalgie

PD10N — Elettrica

Forno principale: OV 60 E3
Forno secondario: OV 40 E3



6 fuochi con fry top*

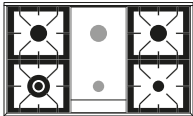

PD10FNE3 *

Ottone/Cromo € 5.303,00
Rame/Brunito € 5.573,00

Nostalgie

P12N — Elettrica

Forno principale: OV 80 E3
Forno secondario: OV 30 E3



7 fuochi

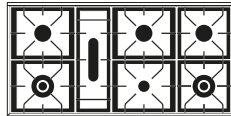

P127NE3 *

Ottone/Cromo € 10.071,00
Rame/Brunito € 10.389,00

Nostalgie

P15N — Elettrica

Forno principale: OV 80 E3
Forno secondario: OV 60 E3



7 fuochi con fry top* e coup de feu

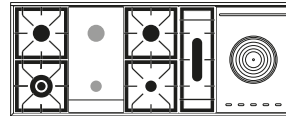

P15FSNE3 *

Ottone/Cromo € 15.124,00
Rame/Brunito € 15.461,00

Nostalgie

P36N — Elettrica

Forno principale: OV 80 PY TFT S
Forno secondario: WD



6 fuochi con fry top*

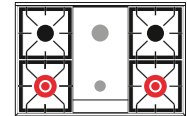

P36FDDNSY

Ottone/Cromo € 6.067,00
Rame/Brunito € 6.219,00

6 fuochi

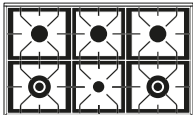

PD106NE3 *

Ottone/Cromo € 4.975,00
Rame/Brunito € 5.244,00

8 fuochi con fry top*

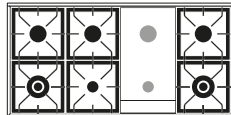

P12FNE3 *

Ottone/Cromo € 10.071,00
Rame/Brunito € 10.389,00

9 fuochi con fry top*

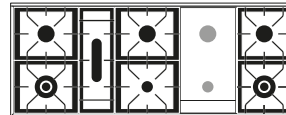

P15FNE3 *

Ottone/Cromo € 15.124,00
Rame/Brunito € 15.461,00

6 fuochi

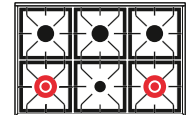

P366DDNSY

Ottone/Cromo € 5.755,00
Rame/Brunito € 5.905,00

Coupe de feu

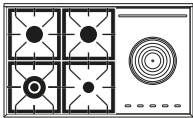

PD10SNE3 *

Ottone/Cromo € 5.212,00
Rame/Brunito € 5.482,00

Coupe de feu

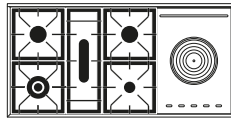

P12SNE3 *

Ottone/Cromo € 10.071,00
Rame/Brunito € 10.389,00

Coupe de feu

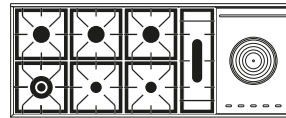

P15SNE3 *

Ottone/Cromo € 15.124,00
Rame/Brunito € 15.461,00

Induzione

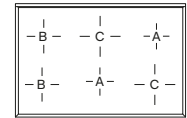

P1366NSY

Ottone/Cromo € 6.447,00
Rame/Brunito € 6.599,00

2 zone induzione

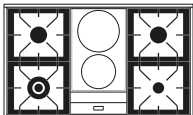

PD10INE3 *

Ottone/Cromo € 5.642,00
Rame/Brunito € 5.912,00

6 fuochi con fry top* e 2 zone induzione

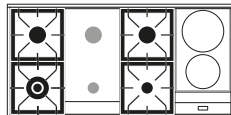

P12FINE3 *

Ottone/Cromo € 10.071,00
Rame/Brunito € 10.389,00

Induzione

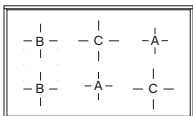

PDI106NE3

Ottone/Cromo € 6.176,00
Rame/Brunito € 6.312,00

Induzione

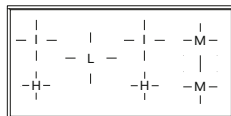

PI127NE3

Ottone/Cromo € 10.071,00
Rame/Brunito € 10.389,00

Professional Plus
P06W — Elettrica

Forno principale: OV 60 E3



4 fuochi

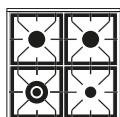

P06WE3 *

Satinato

€ 2.948,00

Professional Plus
P07W — Elettrica

Forno principale: OV 60 E3



4 fuochi

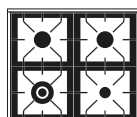

P07WE3 *

Satinato

€ 2.948,00

Professional Plus
P09W — Elettrica

Forno principale: OV 80 E3



6 fuochi con fry top*

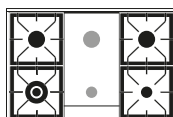

P09FWE3 *

Satinato

€ 4.200,00

Professional Plus
PD09W — Elettrica

Forno principale: OV 60 E3
Forno secondario: OV 30 E3



6 fuochi con fry top*

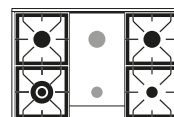

PD09FWE3 *

Satinato

€ 5.020,00

Induzione

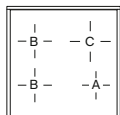

PI06WE3

Satinato

€ 4.034,00

6 fuochi

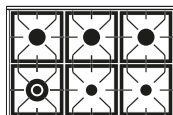

P096WE3 *

Satinato

€ 3.886,00

6 fuochi

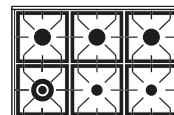

PD096WE3 *

Satinato

€ 4.687,00

Pescera



P09PWE3 *

Satinato

€ 3.849,00

Pescera



PD09PWE3 *

Satinato

€ 4.674,00

2 zone induzione

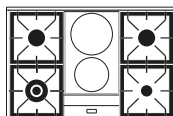

P09IWE3 *

Satinato

€ 4.028,00

2 zone induzione

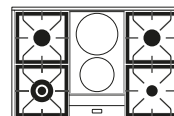

PD09IWE3 *

Satinato

€ 5.297,00

Induzione

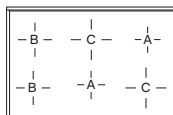

PI096WE3

Satinato

€ 4.987,00

Induzione

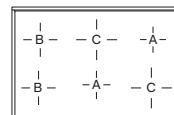

PDI096WE3

Satinato

€ 5.751,00

Professional Plus

PD10W — Elettrica

Forno principale: OV 60 E3
Forno secondario: OV 40 E3



6 fuochi con fry top*

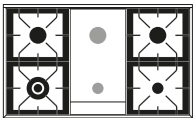

PD10FWE3 *

Satinato € 5.246,00

Professional Plus

P12W — Elettrica

Forno principale: OV 80 E3
Forno secondario: OV 30 E3



7 fuochi

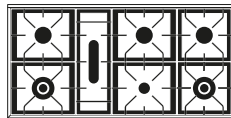

P127WE3

Satinato € 10.071,00

Professional Plus

P15W — Elettrica

Forno principale: OV 80 E3
Forno secondario: OV 60 E3



7 fuochi con fry top* e coup de feu

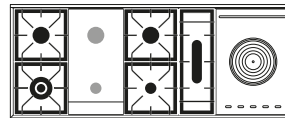

P15FSWE3 *

Satinato € 15.124,00

Professional Plus

P36W — Elettrica

Forno principale: OV 80 PY TFT S
Forno secondario: WD



6 fuochi con fry top*

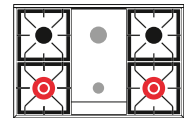

P36FDDWSY

Satinato € 6.027,00

6 fuochi

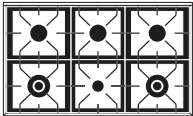

PD106WE3 *

Satinato € 4.916,00

8 fuochi con fry top*

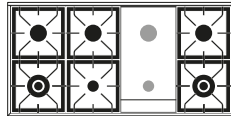

P12FWE3 *

Satinato € 10.071,00

9 fuochi con fry top*

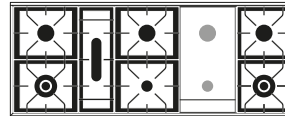

P15FWE3 *

Satinato € 15.124,00

6 fuochi

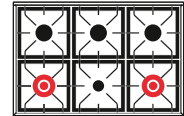

P366DDWSY

Satinato € 5.713,00

Coupe de feu



PD10SWE3 *

Satinato € 5.155,00

Coupe de feu

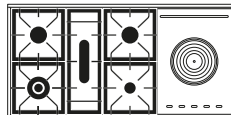

P12SWE3 *

Satinato € 10.071,00

Coupe de feu

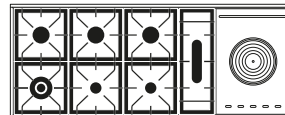

P15SWE3 *

Satinato € 15.124,00

Induzione

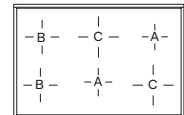

PI366WSY

Satinato € 6.406,00

2 zone induzione

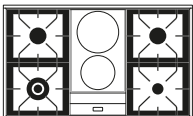

PD10IWE3 *

Satinato € 5.575,00

6 fuochi con fry top* e 2 zone induzione

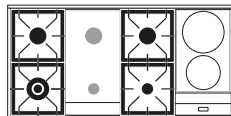

P12FIWE3 *

Satinato € 10.071,00

Induzione

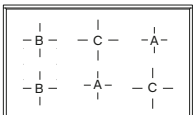

PDI106WE3

Satinato € 6.137,00

Induzione

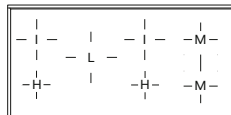

PI127WE3

Satinato € 10.071,00

Pro Line

L09 — Elettrica

Forno principale: OV 80 M3



6 fuochi

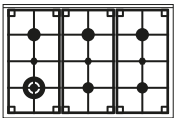

L096WM3

Nero opaco

€ 3.341,00

Pro Line

L09 — Elettrica

Forno principale: OV 80 M3



6 fuochi

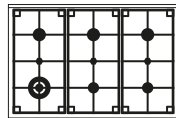

L096WM3

Nero opaco

€ 3.341,00

Pro Line

L06 — Elettrica

Forno principale: OV 60 M3



4 fuochi

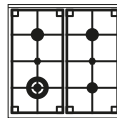

L06WM3

Satinato

€ 2.453,00

Pro Line

L09 — Elettrica

Forno principale: OV 80 M3



5 fuochi

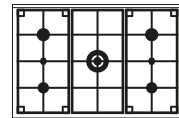

L09CWM3

Satinato

€ 2.940,00

6 fuochi con fry top*

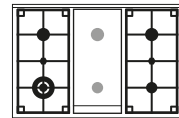

L09FWM3

Satinato

€ 3.256,00

6 fuochi

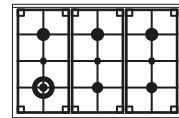

L096WM3

Satinato

€ 3.141,00

Induzione

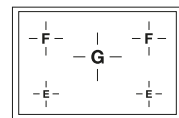

LBI09WM3

Satinato

€ 3.955,00

Pro Line

LD09 — Elettrica

Forno principale: OV 60 M3
Forno secondario: OV 30 E

5 fuochi

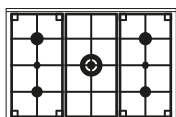

LD09CWM3

Satinato

€ 3.463,00

Pro Line

LD10 — Elettrica

Forno principale: OV 60 M3
Forno secondario: OV 40 E

5 fuochi

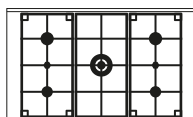

LD10CWM3

Satinato

€ 3.642,00

Pro Line

L12 — Elettrica

Forno principale: OV 80 M3
Forno secondario: OV 30 E

8 fuochi

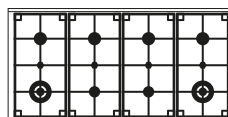

L128WM3

Satinato

€ 7.171,00

6 fuochi con fry top*

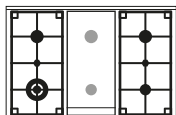

LD09FWM3

Satinato

€ 3.786,00

6 fuochi con fry top*

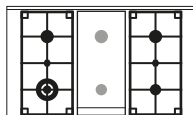

LD10FWM3

Satinato

€ 4.013,00

8 fuochi con fry top*

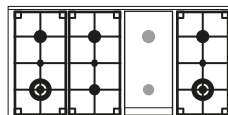

L12FWM3

Satinato

€ 7.338,00

6 fuochi

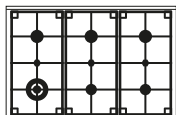

LD096WM3

Satinato

€ 3.670,00

6 fuochi

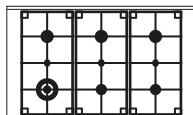

LD106WM3

Satinato

€ 3.838,00

Induzione

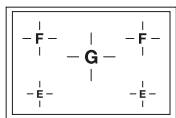

LDBI09WM3

Satinato

€ 4.811,00

Nostalgie, Professional Plus, Pro Line

Mod. /mm	A	B
P06N / P06W / L06	130	80
P07N / P07W	190	150
P09N / P09W / L09	240	150
PD09N / PD09W / LD09	140	80
PD10N / PD10W / LD10	140	80
P12N / P12W / L12	225	90
P15N / P15W	200	135
P36N / P36W	200	150

Vista posteriore
P36N / P36W

Vista posteriore

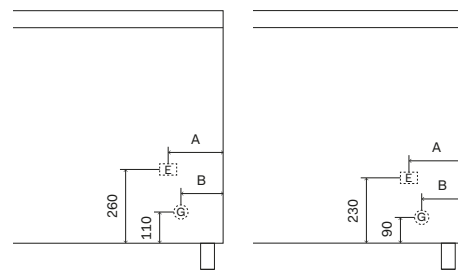

Vista laterale

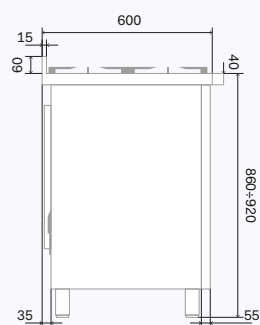

Vista laterale P36N / P36W

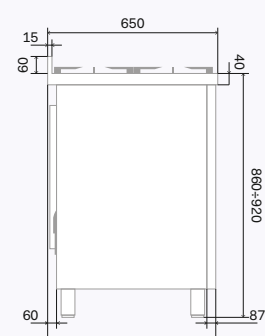

P06N / P06W / L06

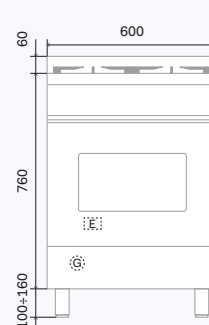

P07N / P07W

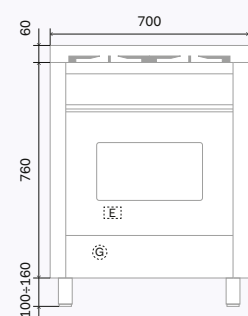

P09N / P09W / L09

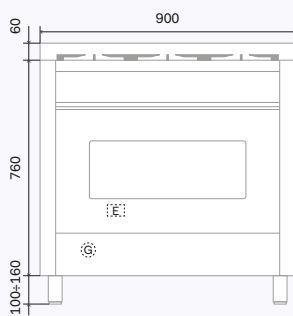

P36N / P36W

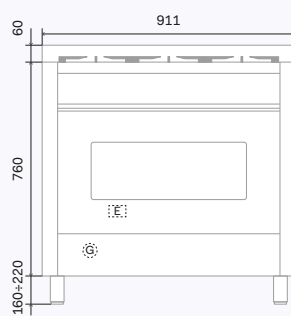

PD09N / PD09W / LD09

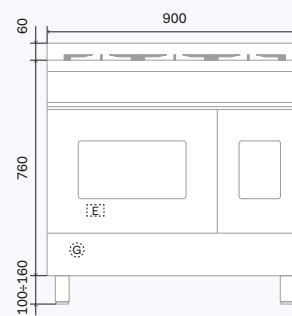

PD10N / PD10W / LD10

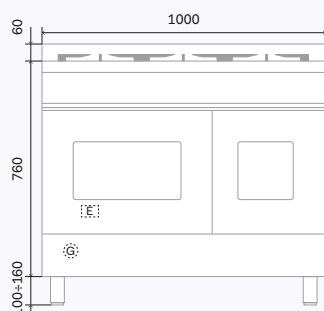

P12N / P12W / L12

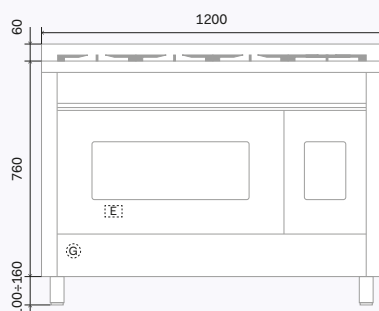

P15N / P15W

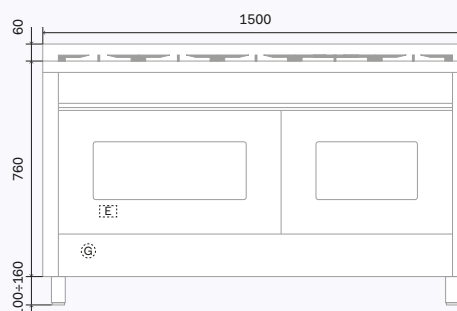

Majestic

Mod. /mm	A	B
M07	205	130
M30	120	80
M09	190	140
MD10	140	95
M12	150	110
M15	195	150

Vista posteriore
- M30

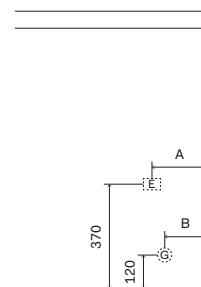

Vista posteriore

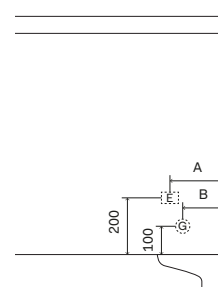

Vista laterale

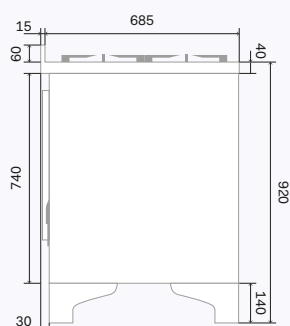

Vista laterale M30

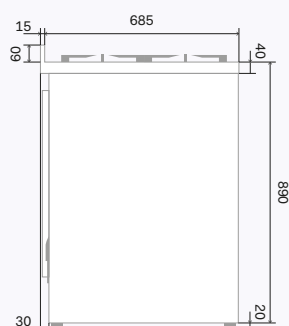

M07

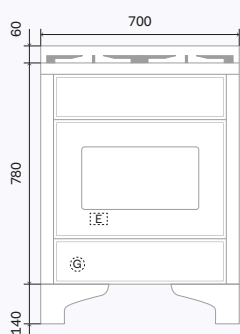

M30

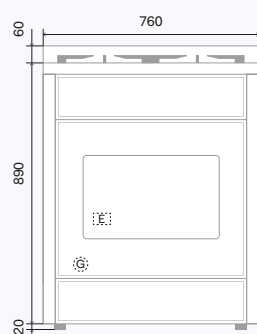

M09

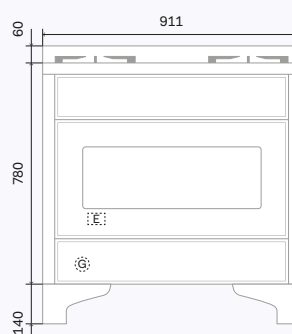

MD10

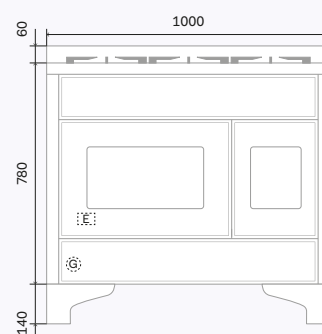

M12

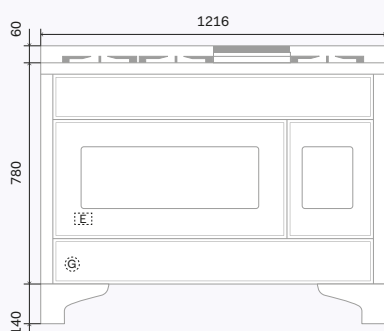

M15

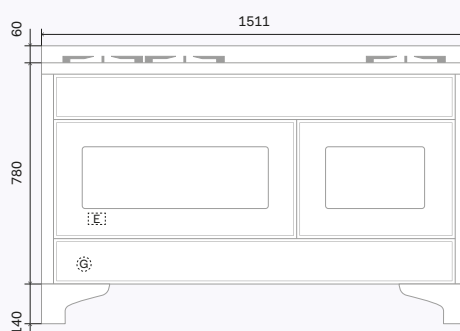

Centri assistenza ILVE Italia

→ Per blocchi cottura, forni e piani cottura

<u>Provincia</u>	<u>Nome</u>	<u>Indirizzo</u>	<u>Telefono</u>	<u>Fax</u>
Abruzzo				
CHIETI e prov.	Euro Service	Via Don Bosco 21 - 65026 Popoli (PE)	085 98492	085 98492
L'AQUILA e prov. est	S.T.E. Facchini Malvino	Via della Stazione Introdacqua 80 - 67039 Sulmona (AQ)	0864 31100	0864 207656
L'AQUILA prov. ovest	Cerasani Alessio	Via S. Cipriano 34/B - 67058 San Benedetto dei Marsi (AQ)	0863 441294	
PESCARA e prov.	Euro Service	Via Don Bosco 21 - 65026 Popoli (PE)	085 98492	085 9879195
TERAMO e prov.	Accorsi Service	Via Nazionale 195 - 64018 Tortoreto Lido (TE)	0861 786777	0861 774609
VASTO e prov.	SassoTec di Sasso Andrea	Contrada Sant'Iorio 13 - 66034 Lanciano (CH)	0873 366955	
Basilicata				
POTENZA e prov.	Dolce Riparazioni	Via Napoli 2/12 - 85100 Potenza (PZ)	0971 443678	0971 443678
MATERA e prov.	Guerricchio Giuseppe	C.da Pedale della Palomba - 75100 Matera (MT)	0835 384735 330 956483	0835 384735
Calabria				
CATANZARO e prov.	Calabretta Francesco	Via F. Ferruccio 46 - 88021 Borgia (CZ)	0961 952587	0961 952587
COSENZA e prov.	SE.RI.EL.CO. Elettrodomestici	Corso Italia 158/P - 87100 Cosenza (CS)	0984 33152	0984 33152
CROTONE e prov.	Tecno Service Veneta	Via Roma 123/125 - 88900 Crotone (KR)	3889488101 3889488102	
GIOIA TAURO e Zone limitrofe	Franco Speranza	Via Circonvallazione 225 - 89029 Taurianova (RC)	0966 645463 0966 645008	0966 643773
REGGIO CALABRIA	DPS Service	Viale Aldo Moro trav. Delfino 55 - 89129 Reggio Calabria (RC)	0965 599203	0965 21189
REGGIO CALABRIA zona Jonica	Malgeri Alessandro	Via Ido Croce 93 - 89040 Martone (CS)	0964 410822	0964 410822
VIBOVALENTIA e prov.	SAT Galati	Via Nazionale S.S. 108 192 - 89851 Jonadi (VV)	0963 263285	0963 263285
Campania				
BENEVENTO e prov.	Federici Addolorata	Via Napoli 123/A - 82100 Benevento (BN)	0824 21425	0824 21425
CASERTA e prov.	S.T.C. di Martone C.	Via Pisciarelli 60/B - 80126 Napoli (NA)	081 7143040	081 19576059
ISOLA DI ISCHIA	Salvato elettrodomestici S.r.l.s.	Via Agostino Depretis 19 - 80133 Napoli (NA)	081 900672	
NAPOLI e prov.	Tekel Service di De Felice Sergio	Via Camillo Guerra 42 - 80131 Napoli (NA)	081 6171820	081 5709209
SALERNO	Baldi Vincenzo	Via Matteo Rossi 25 - 84127 Salerno (SA)	089 796407	
SALERNO e zone limitrofe	Centro Assistenza Tecnica di Galdi D&C	Via Grillo 43 B/C - 84080 Pellezzano (SA)	089 567285 / 7	089 567285 / 7
SALERNO prov. Est	Elettrofast s.n.c di Sbröllini Gianluca &C	Via Nazionale 38/44 - 84036 Sala Consilina (SA)	0975 22675	0975 22675
Emilia Romagna				
BOLOGNA e prov.	CAT di Ocasti Gabriele	Via Delle Ruote - 2/B- 40138 Bologna (BO)	051 534397	051 534397
CESENA e prov	Burnacci Antonio	Via Alberi 9/B - 47100 Forlì (FC)	0543 404849	0543 416866

<u>Provincia</u>	<u>Nome</u>	<u>Indirizzo</u>	<u>Telefono</u>	<u>Fax</u>
Emilia Romagna				
FERRARA e prov.	Ferrocci & Bissi	Via Copparo 6 - 44123 Ferrara (FE)	0532-464675	
FORLI' e prov	Burnacci Antonio	Via Alberi 9/B - 47100 Forlì (FC)	0543 404849	0543 416866
MODENA e prov.	R.E.A.T.	Via Giardini Nord 8 - 41043 Formigine (MO)	059 557168	059 573517
PARMA e prov.	Carpi Service	Via XI Settembre 7 - 43058 Sorbolo (PR)	0521 698955	0521 698955
PIACENZA e prov.	R.E.M. snc di Cordani Roberta	Via Manfredi 110/A - 29122 Piacenza (PC)	0523 716361	
RAVENNA e prov.	Tecnorossi di Rossi Gabriele	Via Cantinelli 41 - 48018 Faenza (RA)	335 7219642	
REGGIO EMILIA e prov.	Tecnorip di Tasselli Luca	Via F. Moscardini - 42016 Guastalla (RE)	347 3269838	
RIMINI e prov.	Rimini Service	Via Emilia 292 - 47821 Santa Giustina (RN)	0541 680832	0541 680832
Friuli Venezia Giulia				
CARNIA	ATRE di Massimiano Zilli	Via Cesare Battisti 46 - 33029 Villa Santina (UD)	0433 747867	
GORIZIA e prov.	Tecnicambi	Via Cologna 32 - 34127 Trieste (TS)	040 578058	040 578058
PORDENONE e prov.	Beppe Cremasco Servizi	Via Mascagni 1 - 31011 Asolo (TV)	360 324271	
TRIESTE e prov.	Sate di Michele Sanapo	Via P.Paolo Vergerio 22 - 34138 Trieste (TS)	040 390750	040 390750
UDINE e prov.	Rimel Service	Via Tavagnacco 131/10 - 33100 Udine (UD)	0432 470836 0432 545879	0432 470834
Lazio				
FROSINONE e prov.	Elettrodomestici Fratangeli	Via Mastruccia 96 - 03100 Frosinone (FR)	0775 870405	
LATINA e prov. Nord e Sud	C.R.I. Service S.r.l.	Via Calegna 21/23 - 04024 Gaeta (LT)	0771 470925	
RIETI e prov.	Pezzotti & Figli	Piazza Marconi 13 - 02100 Rieti (RI)	0746 482623	0746 293157
ROMA e prov.	T.V.S. 92 sas	Via dei Noci 62/64 - 00172 ROMA	06 2314434	
VITERBO e prov.	S.T.E.T	Via A. Gargana 17 - 01100 Viterbo (VT)	0761 304069	
Liguria				
GENOVA e prov.	Reva di Repetto Patrizia S.a.s.	Via Antonio Cei 65/67 - 16132 Genova (GE)	010 352464	
IMPERIA e prov.	Trevisan Marco	Via Vesco 2 - 18038 Sanremo (IM)	0184 1892051	0184 577250
LA SPEZIA e prov.	Gigliola Franco	Viale Italia 403 - 19124 La Spezia (SP)	0187 523386	0187 523386
SAVONA e prov.	Savona Service	Via Aglietto 49 - 17100 Savona (SV)	019 823701	
Lombardia				
BERGAMO e prov.	Bombarda Andrea	Via Nazionale 112 - 24068 Seriate (BG)	035 296425	035 301986
BRESCIA e prov.	Rovetta Giampietro	Via Monte Cimone,11 - 25128 Brescia (BS)	030 311038	030 311038
COMO e prov.	Barbugian Luca	Sede operativa per Como e Lecco	392 5674346	
CREMONA e prov.	C.A.E. di Matarozi	Via Pozzoli 4 - 26100 Cremona (CR)	0372 434971	0372 434777
LECCO e prov.	Barbugian Luca	Sede operativa per Como/Lecco	392 5674346	
LODI e prov.	Prinelli Carlo Ezio	Via Lombardia 11 - Melegnano (MI)	02 98232984	02 9835697
MANTOVA e prov.	S.A.T. di Fava Alberto	Strada Cipata 112 - Loc. Frassino - 46100 Mantova (MN)	0376 368479	0376 368479

<u>Provincia</u>	<u>Nome</u>	<u>Indirizzo</u>	<u>Telefono</u>	<u>Fax</u>
Lombardia				
MILANO e prov.	Barbugian Luca	Via Aurora 31 - 20037 Paderno Dugnano (MI)	02 99040538	02 99040538
PAVIA e prov.	CLS Service S.r.l.s.	Corso Pavia 85/7 - 27029 Vigevano (PV)	0381 42353	
SONDRIO e prov.	C.A.R.E.	Via Vanoni 76/B - 23100 Sondrio (SO)	0342 510888	0342 512510
VAL CAMONICA	S.A.T.E.	via Carobe 51/53 - 25040 Gianico (BS)	0364 531321	0364 528379
VARESE e prov.	BITEC	Via C. Battisti 58 - 21043 Castiglione Olona (VA)	0331 824454	0331 824610
Marche				
ANCONA e prov.	SATE	Via Umani 1 - 60131 Ancona (AN)	071 2868922	071 2868923
ASCOLI PICENO e prov.	Angellotti Rocco	Via San Francesco 29 - 63075 Aquaviva Picena (AP)	348 6006001	
MACERATA e prov.	WI Service Snc	Via Maestri del lavoro 14 - 62019 Recanati (MC)	071 7576096	0733 290205
PESARO e prov.	Zaffini Enrico	Via S. Eusebio 34 - Centro Comm. S. Orso - 61032 FANO (PS)	0721 865885	0721 865885
Molise				
CAMPOBASSO - ISERNIA	D'Alessandro Giovanni	P.zza Molise 84, 85, 86 - 86100 Campobasso (CB)	0874 67349	0874 67349
TERMOLI	Minchillo Ennio	Via Fortore 29 - 86039 Termoli (CB)	348 7094036	
Piemonte				
ALESSANDRIA e prov.	S.A.Tecnica	Corso Alessandria 77 - 15057 Tortona (AL)	0131 861804	0131 868245
ASTI e prov.	ASTI Service di Buttaci P.& C.	Corso Alessandria 177 - 14100 Asti (AT)	0141 272410	0141 440770
BIELLA e prov.	Toniolo Mauro	Via P. Maffei 325 - 13836 Cossato (BI)	015 925038	015 925038
CUNEO e prov. Sud	ELETTROSERVICE Snc	Via Torino 39/H - 12084 Mondovi (CN)	0174 44637	
CUNEO e prov. Nord	C.A.E.R.	Via Giuseppe Verdi 5 - 12042 Bra (CN)	0172 412810	
NOVARA e prov.	ESSECI Riparazioni	Via Risorgimento 386 - 28100 Novara (NO)	0321 679408	0321 033819
TORINO e prov.	R.E.A.T. di Frisina Rita	Corso Unione Sovietica 584 - 10135 Torino (TO)	011 3979817	011 3979817
TORINO città	Creaco SNC	Via Porpora 9 - 10144 Torino (TO)	011 4376511	011 4376853
VERBANIA e prov.	RIPEL	C.so Roma 178 - 28025 Gravellona Toce (VB)	0323 846512	0323 847240
VERCELLI e prov.	Toniolo Mauro	Via P. Maffei 325 - 13836 Cossato (BI)	015 925038	015 925038
Puglia				
BARI e prov.	C.A.T.L. snc	Via Filippo Turati 16-16A-16B 70100 Bari (BA)	080 5461329 080 5486220	080 5468252
BRINDISI e prov.	SADE Soc. Coop.	Via N. Sauro 42/44 - 73040 Melissano (LE)	0833 581918	0833 581918
FOGGIA e prov.	Assistenza tecnica elettrodomestici Foggia soc. coop	Via del Feudo d'Ascoli 41 - 71121 Foggia (FG)	0881 685013	
LECCE e prov.	SADE Soc. Coop.	Via N. Sauro 42/44 - 73040 Melissano (LE)	0833 581918	0833 581918
	Cat.Salento di Caraccio Emanuele	Via Dogliotti 1C - 73042 Casarano (LE)	3775340052	
TARANTO e prov.	Lippolis SRL	Via Magna Grecia 225 - 74121 Taranto (TA)	099 7362572-3	099 7362572-3

<u>Provincia</u>	<u>Nome</u>	<u>Indirizzo</u>	<u>Telefono</u>	<u>Fax</u>
Sardegna				
CAGLIARI e prov.	ATER S.A.S. di Paola Corriga	Via Stromboli 6C - 09032 Assemini (CA)	070 943189	070 943189
NUORO e prov. Nord	Branciforte Service Point	Via Martiri della liberta 98-102 - 08100 Nuoro (NU)	0784 33496	0784 33496
NUORO e prov. Sud	Arras Bruno	Viale Italia Km. 2 - 08045 Lanusei (NU)	0782 42063	
OLBIA e zone limitrofe	FIP S.R.L.S.	Via Roma, 104 A/B - 07026 Olbia (OT)	078928443	
ORISTANO	Tecnoservice	Via Giacomo Matteotti 1 - 09170 Oristano (OR)	0783 303901 335 8162736	
SASSARI e prov.	Assistenza elettrodomestici di Leandro Pisanu	Via D. Millelire 53 B - 07100 Lipunti (SS)	079 6768475	079 6768475
TRAPANI - AGRIGENTO	Il Bomboloia di Pampinella Mariano	P.zza della Repubblica 58 - 91011 Alcamo (TP)	0924 21104	
Sicilia				
CALTANISSETTA e prov.	Classe "A" Service	Via Don Minzoni 144 - 93100 Caltanissetta (CL)	0934 561492	0934 561492
CATANIA - ENNA - RAGUSA - SIRACUSA	A.T.E.L. di S. Lipra	Via C. Colombo 3 - 95030 S. Agata Li Battiati (CT)	095 211595 095 213811	
MESSINA e prov.	Riparazioni Elettrodomestici di Presti Salvatore	Via Stazione 75 - 98060 Oliveri (ME)	335 7477813	
PALERMO e prov.	C.O.R.EL. Service	Via dell'Ermellino 35 - 90125 Palermo (PA)	091 6484230	
Toscana				
AREZZO e prov.	S.A.T. di Amato Stefano	Via Rocca Tedalda 68 - 50145 Firenze (FI)	055 311376	055 311376
EMPOLI	Carradori Srl	Via dei Macelli 1 - 51100 Pistoia (PT)	0573 28284	0573 32413
FIRENZE e prov.	S.A.T. di Amato Stefano	Via Rocca Tedalda 68 - 50136 Firenze (FI)	055 311376	055 311376
GROSSETO e prov.	C.A.T. di Meini Ivo	Via Abruzzo 12 - 58100 Grosseto (GR)	0564 413916	0564 413916
ISOLA D'ELBA	P.M.R. di Marco Pirrone S.a.s.	Via Enos Cerrini 129 - 57021 Venturina Terme (LI)	0565 855636	
LIVORNO città	A.T.E.S.	Via Torino 3/a - 57100 Livorno (LI)	0586 859566	0586 859566
LIVORNO provincia	ATER di Mustacchia Angelo	Via Aurelia 290 - 57016 Rosignano Solvay (LI)	0586 762102	0586 768056
LUCCA e prov.	Rossi Service S.n.c.	Via Del Bozzo 204/A - 55100 S. Donato (LU)	0583 515050	0583 515686
MASSA-CARRARA e prov. Sud	2F di Faïman Filippo	Via Fiorino 2/A - 54031 Carrara - (MS)	0585 634219	
PISA e prov.	Gasperini Mirko	Via Gramsci 78/79 - 56038 Ponsacco (PI)	0587 731743	0587 731743
PISTOIA e prov.	Carradori Srl	Via dei Macelli 1 - 51100 Pistoia (PT)	0573 28284	0573 32413
PRATO	Prato Service	Via Bologna 195/1 195/2 - 50047 Prato (PO)	0574 26702	0574 39231
SIENA e prov.	Pariels Sas	Via B. Tolomei 9 - 53100 Siena (SI)	0577 51159	0577 589454
Trentino Alto Adige				
BOLZANO e prov.	Tecno Assistenza di Pinato Duilio & C.Sas	Via Max Plank 31 - 39100 Bolzano (BZ)	0471 200099	0471 200099
TRENTO e prov.	Servizio Tecnico Elettrodomestici	Via Tommaso Gar 20 - 38100 Trento (TN)	0461 231227	0461 261221
Umbria				
PERUGIA e prov.	A.T.E.	Via S. Penna 110 - 06090 S. Andrea delle Fratte (PG)	075 5271522	075 7821091

<u>Provincia</u>	<u>Nome</u>	<u>Indirizzo</u>	<u>Telefono</u>	<u>Fax</u>
TERNI e prov.	A.E.T.	Via Curio Fornaci 14 - 05100 Terni (TR)	0744 401131 0744 423676	0744 423676
Val d'Aosta				
AOSTA e prov.	A.T.E. di Broccolato & C	Via Caduti Vittime Col Du Mont 17 - 11100 Aosta (AO)	0165 216164	0165 216714
Veneto				
BELLUNO e prov.	Beppe Cremasco	Via Mascagni 1 - 31011 Asolo (TV)	0423 952027 360 324271	0423 952027
PADOVA e prov.	ATLAS Veneta	Viale Navigazione Interna 82 - 35027 Noventa Padovana (PD)	049 8071544	049 8073651
ROVIGO prov. EST	Barbon Service	Via Roma 99 - 45019 Taglio di Po (RO)	0426 660418	0426 349273
TREVISO e prov.	Beppe Cremasco	Via Mascagni 1 - 31011 Asolo (TV)	0423 952027 360 24271	0423 952027
VENEZIA e prov.	CARE di Pieretto Fabrizio	Via Triestina 58 - Favaro Veneto (VE)	348 0314105	
VERONA e prov.	T.M. Service	Via dell'Industria 31 - 37014 Castelnuovo del Garda (VR)	045 7570026	045 7571850
VICENZA e prov.	Tecnoservice di Gastaldello Roberto	Via Bassano 21/A - 35056 Tezze sul Brenta (VI)	0424 592335 335 7781469	



INOX3 SRL

Via Cusano 18 Fr. Poincicco
 33080 Zoppola (Pn)
 Tel. 0434-977502
 Fax 0434-977528
www.inox3.it
info@inox3.it